

1999 FORMULA SAE®

TABLE OF CONTENTS	PAGE NUMBER
1. CONCEPT OF THE COMPETITION	1
2. ELIGIBILITY	2
3. VEHICLE REGULATIONS	3
3.1 Chassis Rules	3
3.1.1 Ground Clearance	3
3.1.2 Wheels and Tires	3
3.1.3 Suspension	3
3.1.4 Steering	3
3.1.5 Brakes	4
3.1.6 Jacking Points	4
3.2 Crash Protection	4
3.2.1 Roll-over Protection	4
3.2.1.1 - 3.2.1.3	5
3.2.2 Side Impact Protection	7
3.2.3 Frontal Impact Protection	9
3.2.3.1 - 3.2.3.5	
3.3 Safety Rules	10
3.3.1 Driver's Restraint System	10
3.3.2 Driver Safety Equipment	12
3.3.2.1 - 3.3.2.7	
3.3.3 Driver Visibility	13
3.3.4 Head Restraints	13
3.3.5 Floor Closeout	13
3.3.6 Steering Wheel	13
3.3.7 Driver Egress	14
3.3.8 Roll Over Stability	14
3.3.9 Kill Switch	14
3.3.10 Fire Protection	14
3.3.11 Batteries	15

3.	VEHICLE REGULATIONS (con't.)	
3.4	Powertrain	15
3.4.1	Engine and Drivetrain	15
3.4.2	Fuel Allowed	15
3.4.3	Fuel System	16
3.4.4	Throttle and Intake Restrictor	17
3.4.5	Muffler and Exhaust System	18
3.5	General	18
3.5.1	Car Number	18
3.5.2	Aerodynamics and Power Ground Effects	19
	3.5.2.1 - 3.5.2.6	
3.5.3	Modifications	19
3.5.4	Fasteners	20
3.5.5	Body and Styling	20
3.5.6	Wheelbase and Vehicle Configuration	20
3.5.7	Flags	20
	Flagging for FSAE™	
4.	COMPETITION	22
4.1	Inspection	22
4.2	Cost Event	23
4.3	Presentation Event	26
4.4	Design Event	27
4.5	Acceleration Event	29
4.6	Skid-Pad	29
4.7	Autocross Event	30
4.8	Endurance Track and Fuel Economy Event	32
4.9	Rules of Conduct	35
	4.9.1 General Rules	36
	4.9.2 Pit Rules	36
	4.9.3 Driving Rules	37
4.10	Definitions	38

APPENDIX

Safety Structure Equivalency Form (see 3.2.1 and 3.2.2)	A-1
Safety and Technical Inspection Check-list (see 4.1)	A-2
Cost Event Addendum (see 4.2)	A-3
Report Format (see 4.2)	A-4/A-5
Presentation Judging (see 4.3)	A-6
Design Judging (see 4.4)	A-7
Action Deadlines	A-8

1999 Formula SAE® Registration Form / Statement of Compliance

1999 FORMULA SAE®

1. CONCEPT OF THE COMPETITION

The Formula SAE® competition is for SAE student members to conceive, design, fabricate, and compete with small formula-style racing cars. The restrictions on the car frame and engine are limited so that the knowledge, creativity, and imagination of the students are challenged. The cars are built with a team effort over a period of about one year and are taken to a host institution for judging and comparison with approximately 100 other competitors from across the nation. The end result is a great experience for young engineers in a meaningful engineering project as well as the opportunity of working in a dedicated team effort.

For the purpose of this competition, the students are to assume that a manufacturing firm has engaged them to produce a prototype car for evaluation as a production item. The intended sales market is the nonprofessional weekend autocross racer. Therefore, the car must have very high performance in terms of its acceleration, braking, and handling qualities. The car must be low in cost, easy to maintain, and reliable. In addition, the car's marketability is enhanced by other factors such as aesthetics, comfort and use of common parts. The manufacturing firm is planning to produce 1000 cars per year at a cost below \$9000. The challenge to the design team is to design and fabricate a prototype car that best meets these goals and intents. Each design will be compared and judged with other competing designs to determine the best overall car.

The cars are judged in three different categories: static inspection and engineering design, solo performance trials, and high performance track endurance. These events are scored to determine how well the car performs. In each event, the manufacturing firm has specified minimum acceptable performance levels that are reflected in the scoring equations. The following points are possible:

75	Presentation
150	Engineering Design
100	Cost Analysis
75	Acceleration
50	Skid-Pad Event
150	Autocross Event
50	Fuel Economy Event
<u>350</u>	Endurance Track Event
1,000	Total Points

YEAR	HOST	WINNER
1998	Formula SAE® Consortium	Cornell University
1997	Formula SAE® Consortium	Cornell University
1996	Formula SAE® Consortium	University of Texas-Arlington
1995	Formula SAE® Consortium	University of Texas-Arlington
1994	Formula SAE® Consortium	University of Michigan-Ann Arbor
1993	Chrysler Corporation	Cornell University
1992	Ford Motor Company	Cornell University

YEAR	HOST	WINNER
1991	General Motors Corporation	Virginia Tech
1990	Lawrence Institute of Technology	University of Texas-Arlington
1989	University of Texas-San Antonio	University of Texas-Arlington
1988	Lawrence Institute of Technology	Cornell University
1987	University of Texas-Arlington	University of Maryland
1986	Lawrence Institute of Technology	University of Texas-Arlington
1985	University of Texas-Austin	University of Texas-Arlington
1984	University of Texas-Austin	University of Texas-Houston
1983	University of Texas-Austin	University of Texas-Arlington
1982	University of Texas-Austin	University of Texas-Austin
1981	University of Texas-Austin	Stevens Institute of Technology

2. ELIGIBILITY

Eligibility is limited to students taking credit toward a degree and that are student members of SAE. In order to maintain the credibility of fair competition at the Formula SAE® competition, the Faculty Advisor must prohibit "ringers". A ringer is someone that has exceptional skills related to the competition (e.g. driver) and is not fully integrated into the normal team activities but attends the competition to help win points.

The car must be conceived, designed, and fabricated by the students without direct involvement from professional engineers, automotive engineers, racers, machinists, or related professionals. **No school will be allowed to enter more than one car.** The student team may use any literature or knowledge related to car design and information from professionals or from academics as long as the information is given as a discussion of alternatives with their pros and cons. **However, professionals may not make design decisions or drawings and the Faculty Advisor must sign a statement of compliance, as given in the Appendix as A-1, with this restriction. It is the intent of SAE Collegiate Design Series competitions to provide direct hands-on experience to the students. Therefore, it is desired that students perform all fabrication tasks whenever possible.** Eligibility is limited to students to insure that this is an engineering competition rather than a race. Winning is more related to engineering professionalism than to who crosses the finish line first.

To avoid the possibility of new students merely bringing last year's car to the competition and therefore missing the engineering experience, cars that have been entered in two or more previous Formula SAE® competitions are prohibited. Second year cars are allowed in the 1999 competition. A first year car will be classified as a car with a completely new frame. Photographic evidence will be used to determine whether the frame is new. If a team wants to continue with a car design for more than one year, photographic documentation proving that the car was significantly modified, along with a **statement from the Faculty Advisor is required.** The design judges will deduct 20 points from the final design score for cars without a new frame. In addition, the design judges may also deduct an additional 30 points if the photographic documentation shows that the remaining parts of the vehicle have not been significantly changed (ex. The intake manifold is obviously the same or it is obvious that the old suspension was simply bolted to a new frame, or none of the team members show an understanding of the design of the various components). If the new frame is similar to last years, it is advisable to bring along evidence of the change (bringing along the old frame is not a bad idea). Utilizing an old vehicle from several years back is not permissible under any

circumstances. If caught, the team will not be allowed to compete, and will be required to submit photographic evidence of a newly built vehicle before registration will be accepted in future years.

The Faculty Advisor must accompany the team to the competition but is not allowed to provide hands-on help to the team or serve as a team member during the actual competition. The Faculty Advisor will serve as a liaison between the team and the officials and will make any communications of protest or complaints to the judges. The Faculty Advisor will oversee the school's responsibilities on and off the track.

3. VEHICLE REGULATIONS

The following mandatory restrictions will be enforced by the judges through inspection. **Noncompliance must be corrected and the car re-inspected before the car is allowed to compete in the performance events.**

3.1 Chassis Rules

3.1.1 Ground Clearance

Ground Clearance must be sufficient to prevent any portion of the car (other than tires) from touching the ground during track events.

3.1.2 Wheels and Tires

The wheels of the car must be 20.32 cm (8 inches) or more in diameter. The tires can be any size or type. Tire or wheel type, compound or size may not be changed after the static judging has begun. Tire warmers are not allowed. No traction enhancers may be applied to the tires after the static judging has begun.

3.1.3 Suspension

The car must be equipped with a fully-operational suspension system with shock absorbers, front and rear, with usable wheel travel of at least **50 mm** (2 inches) **25 mm** (1 inch) jounce and **25 mm** (1 inch) rebound with driver seated. The judges reserve the right to disqualify cars which do not represent a serious attempt at an operational suspension system or which demonstrate unsafe handling.

3.1.4 Steering

The steering system must affect at least two wheels. The steering system must have positive steering stops which prevent the steering linkages from locking up (the inversion of a four-bar linkage at one of the pivots). The stops may be placed on the uprights or on the rack and must prevent the tires from contacting suspension, body, or frame members during the track events. Allowable steering free play will be limited to 7 degrees total measured at the steering wheel.

3.1.5 Brakes

The car must be equipped with a brake system acting upon all four wheels and must be capable of providing four-wheel lockup on dry asphalt at any speed. **A single brake acting on a limited-slip differential is acceptable.** The brake system must be protected with scatter shields from failure of the drivetrain or from minor collisions. The car must be equipped with a brake light of at least 15 watts clearly visible from the rear. Unarmored plastic brake lines are prohibited.

3.1.6 Jacking Points

A jacking point which is capable of supporting the car's weight and of engaging the organizers' "quick jacks", must be provided at the rear of the car. The jacking point shall be:

- Oriented horizontally and perpendicular to the centerline of the car
- Made from round, 25.4 mm (1 inch) O.D. aluminum or steel tube
- A minimum of 300 mm (11.8 inches) long
- Exposed around the lower 180 degrees of its circumference over a minimum length of 280 mm (11 in)

The height of the tube shall be such that:

- There is a minimum of 75 mm (3 in) clearance from the bottom of the tube to the ground measured at tech inspection,
- With the bottom of the tube 200 mm (7.9 in) above ground, the wheels do not touch the ground when they are in full rebound.

3.2 Crash Protection

3.2.1 Roll-over Protection

The driver's head and hands must be protected from contact with the ground in any roll-over attitude. This requires a main hoop (roll bar) near the driver and a front hoop no lower than the top of the steering wheel as shown in **Figure 1**. Both the main hoop and front hoop must be formed of a continuous closed section tubing attached securely to the primary structure. As a minimum the main hoop and front hoop must be constructed of mild steel (SAE 1010, 1020, 1025) tube with 25.4 mm (1 inch) O.D. and 2.41 mm (0.095 inch) nominal wall thickness, or alloy steel (SAE 4125, 4130) T-45) tube with 25.4 mm (1 inch) O.D. and 1.65 mm (0.065 inch) nominal wall thickness. No composite materials are allowed for the main hoop or front hoop. For all tubing less than 2.41 mm wall thickness, the lettering must remain exposed on the tubing or receipts must be provided at tech inspection.

FIGURE 1

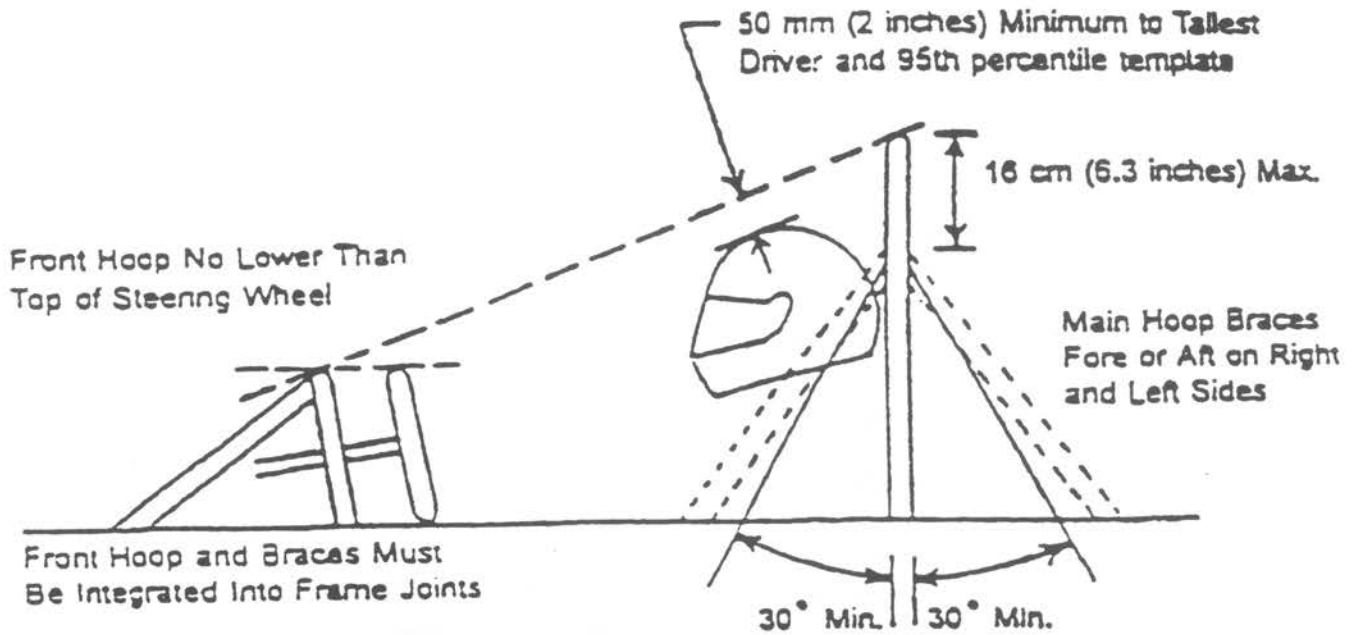

If any other material is used (e.g., aluminum), the team must present documentation of material type (purchase receipt, shipping document or letter of donation, material properties, heat treatment). The team must also submit calculations demonstrating equivalence for energy dissipation, yield and ultimate strengths in bending, buckling, and tension. **The completed Safety Structure Equivalency Form, as given in Appendix A-1, must be submitted to the host no later than March 1, 1999.**

A 4.5 mm (0.18 inch) inspection hole must be drilled in a non-critical location of both the main hoop and the front hoop to allow verification of wall thickness.

3.2.1.1 **Main Hoop**

The main hoop must be constructed of tubing per above. ***In the side view of the vehicle, the main hoop shall be within 10 degrees of the vertical.*** The minimum bend radius must not be less than three times the tube diameter measured from the tube centerline. When seated normally and restrained by the seat belt/shoulder harness, a straight line drawn from the top of the main hoop to the top of the front hoop must clear by 50 mm (2 inches) both the tallest driver's helmet and the helmet of a 95th percentile male (anthropometric data). A two dimensional cardboard template, consisting of two 30 cm (11.8 inch) circles connected such that the centers of the circles are 70 cm (27.6 inches) apart, will be used to represent the 95th percentile male and ensure compliance. With the seat adjusted to the rearmost position, the bottom circle will be placed in the seat, and the upper circle, representing the helmet, will be positioned up to 25 mm (1 inch) away from the head restraint (i.e. where the driver's helmet would normally be located while driving).

The vertical members of the main hoop must not be less than 38 cm (15 inches) apart (inside dimension) at their attachment to the chassis. If the hoop does not go to the belly pan, proper gussets and tube triangulation must be used under its attachment. On monocoque chassis the main hoop must be welded to mounting plates not less than 2.03 mm (0.080 inch) thick. It is important that these plates be attached to the chassis in such a way as to spread the loads over a wide area. There must be a plate of equal thickness on the inside of the monocoque with solid rivets or bolts 8 mm (5/16 inch) minimum bolt diameter through the nonferrous material.

3.2.1.2 **Front Hoop**

The front hoop must be no lower than the top of the steering wheel in any angular position. It is recommended the hoop extend to the belly pan. If not, it must be attached to the chassis with gussets and triangulation in order to spread the loads.

3.2.1.3 **Roll Hoop Bracing**

- a) The main hoop must be braced in the fore or aft direction on the left and right sides. ***In side view, the main hoop and the main hoop bracing cannot be on the same side of the vertical, i.e. if the main hoop leans forward, the bracing must be forward of the main hoop, and if the main hoop leans rearward, the bracing must be rearward of the main hoop.*** Braces must be attached as near as possible to the top of the hoop but must not be more than 16 cm (6.3 inches) below the top and at an included angle of at least 30 degrees. Braces attached to monocoque chassis must be welded to plates not less than 2.03 mm (0.080 inch) thick and backed up on the inner side by plates of equal thickness using solid rivets or bolts 8 mm (5/16 inch) minimum bolt diameter through the nonferrous material.
- b) ***The front hoop must have two braces extending forward to protect the driver's legs. These braces shall be attached as near as possible to the top of the hoop, but must not be more than 5 cm (2 in.) below the top of the hoop.*** It is recommended that this bracing extend to the bulkhead in front of the driver's feet; but in any case it must be integrated into the chassis to provide substantial support for the front hoop. When monocoque construction is used as bracing for the front hoop, it must be approved on an individual basis.
- c) Roll hoop bracing may be removable but must incorporate connectors of the double-lug, tapered, or muff-type as shown in **Figures 2, 3, and 4**. The double-lug type must include a doubler, gusset, or capping arrangement to avoid distortion or excessive strain caused by welding.

- d) Both main hoop and front hoop bracing must be constructed of 25.4 mm x 1.65 mm (1.00 inch x 0.065 inch) mild steel (SAE 1010, 1020, 1025) tubing or 25.4 mm x 1.25 mm (1.00 inch x 0.049 inch) alloy steel (SAE 4125, 4130).

REMOVABLE ROLL BAR BRACES ATTACHMENT DETAILS (FIGURES 2, 3,4)

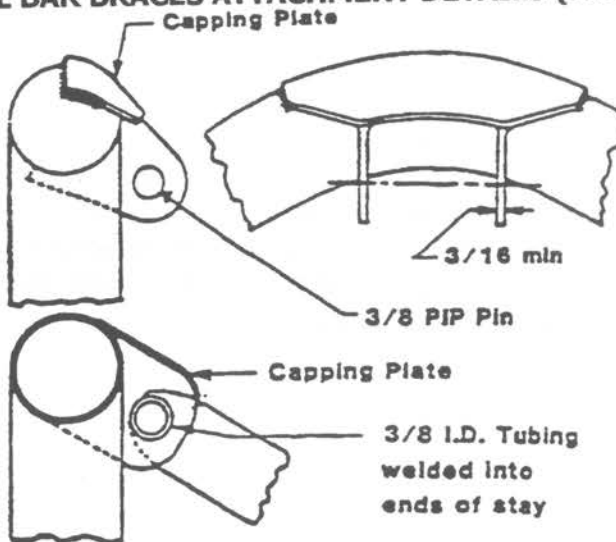

FIGURE 2

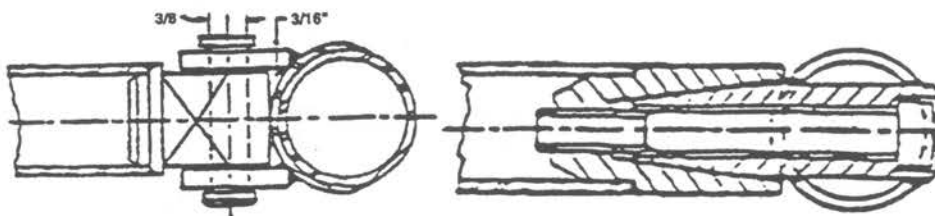

FIGURE 3

FIGURE 4

3.2.2 Side Impact Protection

The driver must be protected from a side collision while seated in the normal driving position. Side impact must meet the requirements listed below. **See figure 5.**

Tube Frames - A frame member must connect the **main roll hoop** and the front roll hoop at a height between 200 and 350 mm (7.87 and 13.78 inches) above the ground with a 77 kg (170 pound) driver seated in the normal driving position. At least one (1) diagonal frame member per side must connect the upper and lower frame members forward of the roll bar and rearward of the front roll hoop. For the purpose of this rule, the upper, lower, and diagonal frame members (or equivalent side impact structure) **must be** 25.4 mm x 1.65 mm (1.00 inch x .065 inch) mild steel tubing or equivalent.

Composite Monocoque - The section properties of the sides of the vehicle must reflect impact considerations. Bodies or skins which are non structural are not adequate to meet the side impact rule. A team may submit a proposed section for approval. The approval process will be based upon the engineering judgement and experience of the technical judge. Submitted information should include: material type(s), cloth weights, resin type, fiber orientation, number or layers, core material, and lay-up technique.

Metal Monocoque - These structures must meet the same requirements as tube frames and composite monocoque unless exempted through technical review. Vehicle designs which protect the driver to an equal or greater extent than required will be allowed, provided they have been judged as such in the technical review. **The completed Safety Structure Equivalency Form as given in the Appendix as A-1, must be submitted to the host no later than March 1, 1999.**

FIGURE 5

SIDE IMPACT PROTECTION

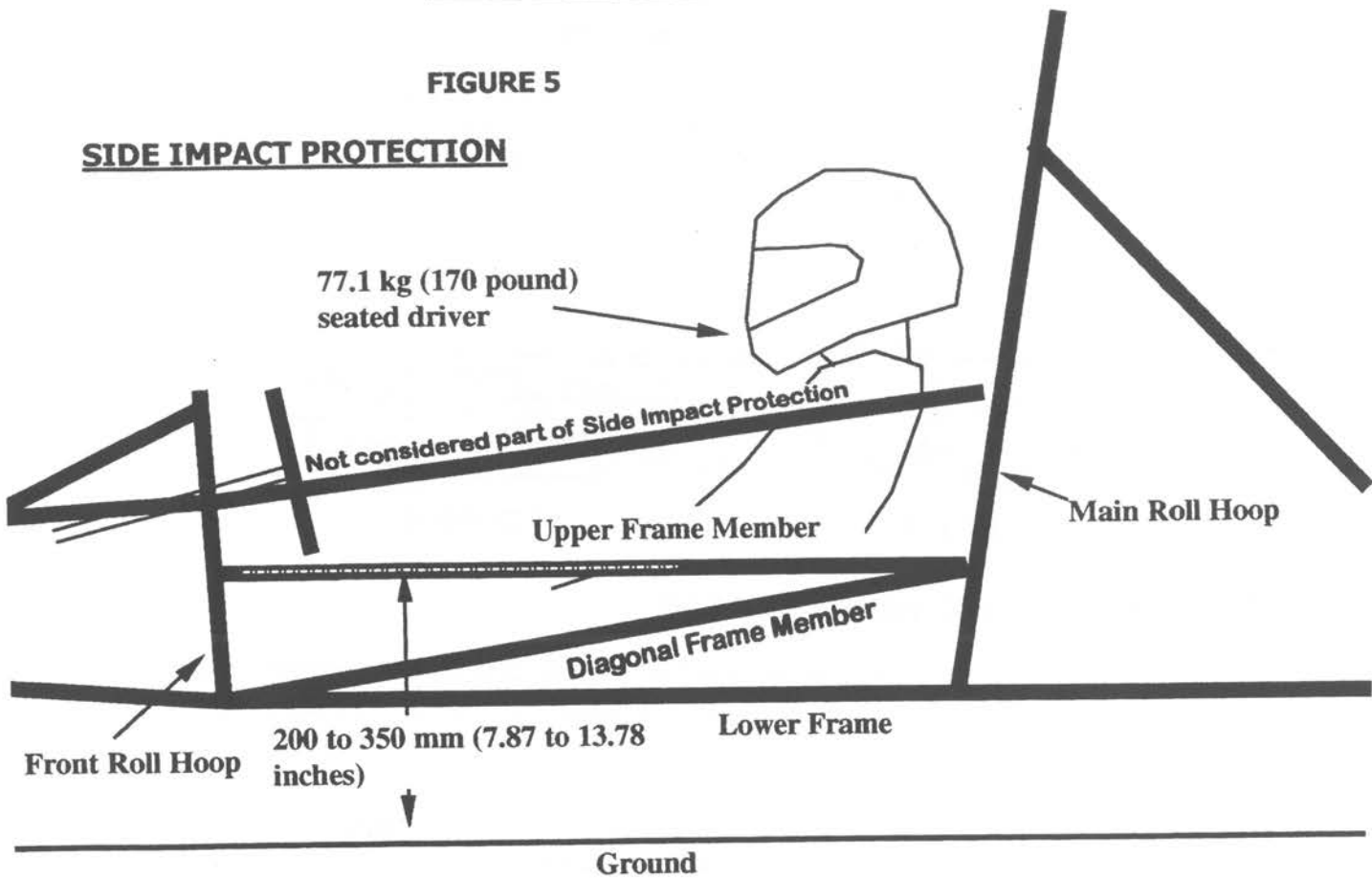

Minimum Requirement for Upper, Lower, and Diagonal Frame Members:

Round Steel Tubing (SAE 1010, 1020, 1025, mild steel)
25.4 mm O.D. x 1.65 mm wall thickness
(1.0 inch O.D. x 0.065 inch wall thickness)

Round Alloy Steel Tubing (SAE 4125, 4130)
25.4 mm O.D. x 1.25 mm wall thickness
(1.0 inch O.D. x 0.049 inch wall thickness)

3.2.3 Frontal Impact Protection

In order to provide protection from frontal impact, the driver's feet shall be contained within the major structure of the chassis at all times. Forward of the major structure shall be 150 mm (5.91 inches) of crush zone as defined below. The planes defined below are normal to the fore/aft axis of the car.

- 3.2.3.1 The rearward plane of the crush zone will begin at the lowest point on the driver's heel or the forward surface of the master cylinder, whichever is further forward. This will be measured with pedals in the furthest forward position.
- 3.2.3.2 The forward plane of the crush zone is the forward most plane in which:
- a) the top of the structure is at least 100 mm (3.94 inch) above the bottom of the structure
 - b) the distance between the outer surfaces of the structure is at least 200 mm (7.87 inch).
- 3.2.3.3 Non-crushable contents (e.g., batteries) may be located between the forward and rearward planes, but their fore/aft thickness will be subtracted from the distance between the planes to determine the thickness of the crush zone.
- 3.2.3.4 Persons outside the car should not be endangered by contact with sharp points or projection on the parts of the forward facing bodywork. The minimum radius of the nose or other similar forward facing three-dimensional part of the car that is likely to impact people shall be 38 mm (1.5 inches). This radius shall be held to at least that value over the part of the nose or similar part within 45 degrees of the forward direction. This rule may be checked in technical inspection using a section of a hollow ball with a 76 mm ID or similar templates.
- 3.2.3.5 Any material that is to be considered as frontal impact protection must be attached securely and directly to the frame of the vehicle. Front impact protection cannot be attached to the vehicle by being part of the bodywork (i.e. If a foam plug is used, it must be attached to the frame, not the nose-piece of the bodywork).

3.3 Safety Rules

3.3.1 Driver's Restraint System

All drivers must use either a five or six-point restraint harness meeting the following specifications. Arm restraints are also required. The restraint system installation is subject to approval of the SCCA Chief Technical and Safety Inspector. The restraint system must be worn as tightly as possible at all times.

- a) A five-point system, recommended for use in cars where the driver is seated in an upright position, consists of a 76 mm (3 inch) wide lap belt, approximately 50 mm (2 inch) wide shoulder harness straps, and approximately a 50 mm (2 inch) wide anti-submarine strap.
- b) A six point system, recommended for use in cars where the driver is seated in a semi-reclining position, consists of a 76 mm (3 inch) wide lap belt, approximately 50 mm (2 inch) wide shoulder harness straps, and approximately two 50 mm (2 inch) wide leg or anti-submarine straps.
- c) The material of all straps must be Nylon or Dacron polyester and in new or perfect condition. There must be a single release common to the lap belt and shoulder harness using a metal-to-metal quick-release type latch. All driver restraint systems must meet SFI Specifications 16.1., and must bear a dated "SFI Spec 16.1., Label," no more than five years old. It is recommended that driver restraint systems be replaced every three years.
- d) The lap belt, shoulder harness and anti-submarine strap(s) should be securely mounted to the primary structure of the car (i.e. frame tubes, roll structure). Where this is not possible, large diameter mounting washers or equivalent must be used to spread the load. Bolting through aluminum floor closeout panels, etc. is not acceptable.
- e) The lap belt must pass around the pelvic area below the Anterior Superior Iliac Spines (***the hip bones***) (**Figure 6**). Under no condition may the lap belt be worn over the area of the intestines or abdomen. The lap belts should come through the seat at the bottom of the sides of the seat to maximize the wrap of the pelvic surface and continue in a straight line to the anchorage point. The centerline of the lap belt at the seat bottom should be approximately 75 mm (3 inch) forward of the seat back to seat bottom junction (see Recommended Location in **Figure 6**). The lap belts should not be routed over the sides of the seat. The seat must be rolled or grommeted to prevent chafing of the belts.

**Figure 6
DRIVER RESTRAINT**

SHOULDER HARNESS SHOULD BE INSTALLED 90 DEGREE TO SPINE AT SHOULDER LINE TO MINIMIZE COMPRESSION INJURIES UNDER HIGH "G" LOADING

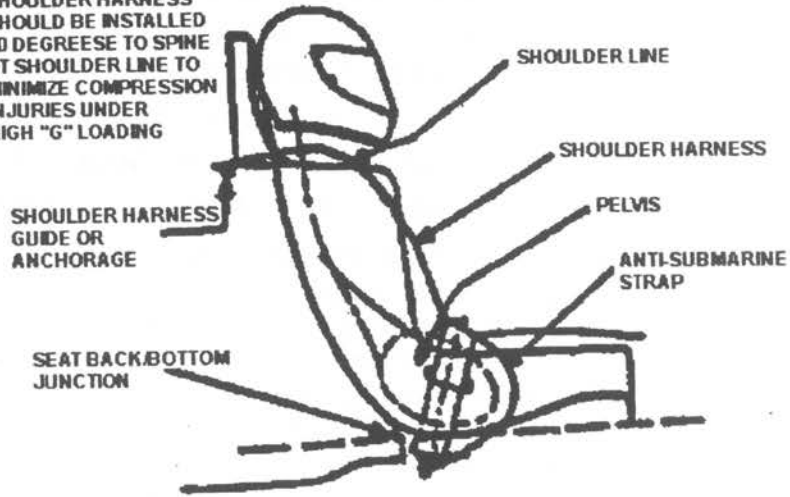

3.0 MIN. MAX. TO CENTERLINE OF LAP BELT AT SEAT BACK SEAT BOTTOM JUNCTION
LAP BELT SHOULD CONTINUE IN STRAIGHT LINE TO ANCHORAGE

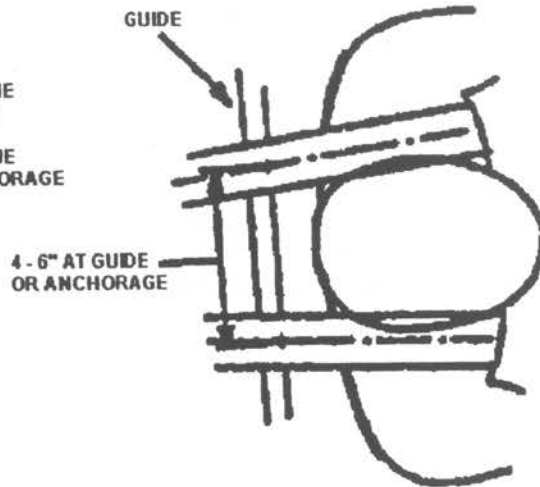

DRAWN
C. Normand

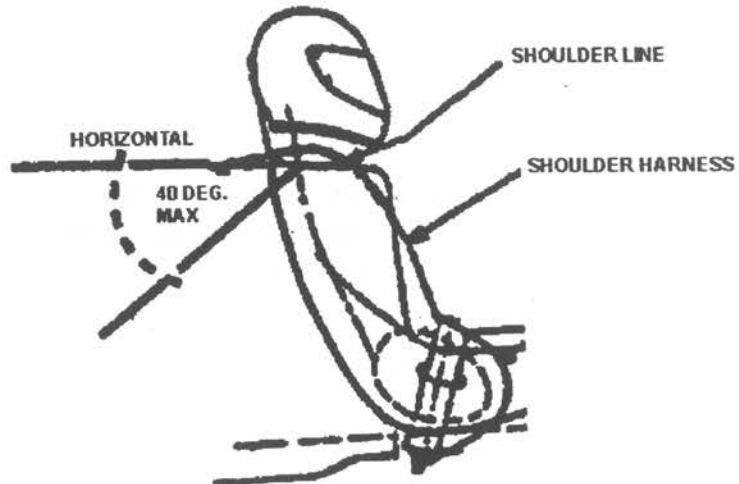

- f) The shoulder harness must be the over-the shoulder type. The shoulder harness must be mounted behind the driver and above a line drawn downward from the shoulder point at an angle of 40 degrees with the horizontal to minimize spine compression injuries under high "g" deceleration. ***In cases where the driver is in a semi-reclining position, the shoulder harness shall be attached so that the angle between a line drawn upward through the driver's spine and the shoulder harness is 45 degrees or greater.*** Only separate shoulder straps are permitted (i.e. "Y"-type shoulder straps are not allowed). "H"-type configuration is allowed. It is recommended that the shoulder harness, where it passes over the shoulders, be 75 mm (3 inch) wide or have 75 mm (3 inch) wide padding. The shoulder harness straps must be threaded through the three bar adjusters in accordance with manufacturers instructions.
- g) The single anti-submarine strap of the five-point system must be attached to the primary structure and have a metal-to-metal connection with the single release common to the lap belt and shoulder harness.
- h) The double leg straps of the six-point system may be attached to the primary structure or be attached to the lap belt so that the driver sits on them, passing them up between his or her legs and attaching to the single release common to the lap belt and shoulder harness. The leg straps may also be secured at a point common with the lap belt attachment to the structure, passing them under the driver and up between his or her legs to the harness release.

3.3.2 Driver Safety Equipment

The following equipment must be worn at any time a driver is seated in the vehicle and the engine is running or being started:

- 3.3.2.1 A well-fitting safety helmet with a Snell M85, SA-85, M90 or SA-90 rating. All helmets to be used in the competition must be presented during Safety and Technical Inspection where approved helmets will be stickered. The host reserves the right to impound all non-approved helmets until the end of the competition.
- 3.3.2.2 A fire resistant suit that covers the body from the neck down to the ankles and the wrists. The suit shall be manufactured from one or more of the following accepted materials: Nomex, Kynol, FPT, IWS (wool), Fiberglass, Durette, Fypro, PBI and Kevlar. **PROBAN is not allowed.** All driver's suits must meet SFI 3.2A and be labeled as such.
- 3.3.2.3 Fire resistant gloves which are free of any holes. Leather gloves are not acceptable.
- 3.3.2.4 Goggles or face shields, made of impact resistant materials.

3.3.2.5 Shoes of durable fire resistant material, and which are free from any holes.

3.3.2.6 Arm restraints must also be installed on the car in a manner such that the driver can release them and exit the vehicle unassisted regardless of the vehicle's position.

3.3.2.7 *Hair protruding from beneath a driver's helmet shall be completely covered by fire resistant material, i.e. a Nomex balaclava or a full helmet skirt of accepted fire resistant material.*

3.3.3 Driver Visibility

The car must be equipped with functional rear-view mirrors. The driver must have adequate visibility to the front, rear, and sides. Undersized or token mirrors are not acceptable. The driver's head must be free to rotate 90 degrees to either side.

3.3.4 Head Restraints

A restraint must be provided on the car to limit rearward motion of the head in the case of an accident. ***The restraint shall be a padded non-resilient material such as Ethafoam® or Ensolite® with a minimum thickness of 38mm (1.5 inches), located no more than 25 mm (1 inch) away from the helmet in the uncompressed state.*** The head restraint must meet the above requirements for all drivers. It is recommended that the surface be 2 dm squared (36 square inches).

Any portion of the roll bar or bracing which might be contacted by the driver's helmet shall be covered with styrofoam or other energy-absorbing material, minimum of 32 kg/m³ (2 lbs/ft³) polystyrene or equivalent, to a minimum thickness of 12 mm (0.5 inch).

3.3.5 Floor Closeout

All vehicles must have a floor closeout made of one or more panels which separate the driver from the pavement. If multiple panels are used, gaps between panels are not to exceed 3 mm (1/8 inch). The closeout must extend from the foot area to the firewall and must protect the legs and torso from track debris.

3.3.6 Steering Wheel

The steering wheel must have a near circular perimeter. "H", "Figure-8", or cutout wheels are not allowed. The steering wheel must be attached to the column with a quick disconnect. The driver must be able to operate the quick disconnect while in the normal driving position with gloves on.

3.3.7 Driver Egress

All drivers must be able to exit to the side of the vehicle in no more than 5 seconds.

Egress time begins with the driver in the fully seated position, hands in driving position on the connected steering wheel, wearing the required driver safety equipment. Egress time will stop when the driver has both feet on the pavement.

3.3.8 Roll Over Stability

The track and center of gravity of the car must combine to provide adequate roll-over stability. Roll-over stability will be evaluated using a pass/fail test. The vehicle must not roll when tilted at an angle of 57 degrees in either direction corresponding to 1.5 G's. The tilt test will be conducted with the tallest driver in the normal driving position.

3.3.9 Kill Switch

The car must be equipped with two positive kill switches affecting the entire electrical system of the car. One switch must be located on the (driver's) right side of the vehicle, in the proximity of the roll bar at shoulder height, within easy reach from outside the car, and the other switch must be located for easy operation by the driver.

The SCCA electrical symbol must be attached near both switches and the "run" and "kill" position must be clearly labeled.

3.3.10 Fire Protection

A firewall must separate the driver compartment from all components of the fuel supply and liquid cooling systems. **The firewall must be a non-permeable surface made from a fire resistant material.** Pass throughs for wiring, cables, etc. are allowable if grommets are used to seal the pass throughs. Also, multiple panels may be used to form the firewall but must be sealed at the joints to meet the intent of driver protection.

HAND HELD OR ANY TYPE OF PORTABLE/MANUALLY OPERATED FIRE EXTINGUISHERS ARE NO LONGER PERMITTED TO BE MOUNTED ON OR IN THE CAR. However, as a team option, commercially available on-board fire systems are permitted. Each team shall have at least one 0.9 kg (2 lb.) dry chemical 10BC or 1A10BC, 2 lb. Halon 1301 or 1211, AFFF, or CEA-614 fire extinguisher readily available in their paddock area. In addition, each team shall have a second extinguisher that will accompany the vehicle wherever the vehicle is moved. All extinguishers

must be equipped with a manufacturer installed pressure/charge gauge, must meet the above specifications and must be presented with the vehicle at Tech Inspection.

3.3.11 Batteries

All batteries (on-board power supplies) must be attached securely to the frame or chassis structure. If located in the cockpit, wet cell batteries must be in a nonconductive marine type container or equivalent. The hot terminal must be insulated on all cars.

3.4 Powertrain

3.4.1 Engine and Drivetrain

The engine used to power the car may be any four-cycle piston engine with 610 cc displacement per cycle or less. The engine can be modified within the restrictions of the rules. The host will measure or tear down a substantial number of engines to confirm conformance to the rules. The initial measurement will be made externally with a measurement accuracy of one (1) percent. When installed to and coaxially with spark plug hole, the measurement tool has dimensions of 381 mm (15 inches) long and 30 mm (1.2 inches) diameter. Teams may choose to design in access space for this tool above each spark plug hole to reduce time should their vehicle be inspected.

The engine and transmission must be sealed to prevent leakage. In addition, separate catch cans must be employed to retain fluids from any vents for the coolant system and the crankcase. Each can must have a volume of ten (10) percent of the fluid being contained or 0.9 liter (one quart), whichever is greater.

Water-cooled engines must only use plain water, or water with cooling system rust and corrosion inhibitor at no more than .015 liters per liter of plain water. Glycol-based antifreeze or water pump lubricants of any kind are strictly prohibited.

Any transmission and drive train may be used. Exposed high-speed equipment, such as torque converters, clutches, belt drives and clutch drive, must be fitted with scatter shields of at least 12 gauge 2.67 mm (0.105 inch) mild steel (or documented equivalent ultimate strength and equivalent safety) to protect drivers, bystanders, fuel lines and safety equipment (such as brake lines) from flying debris in case of failure. Guards for finger protection may be made of lighter material.

3.4.2 Fuel Allowed

During all performance events, the cars must be operated with gasoline (auto gas, aviation fuel, or racing gas) or M85. No other fuel (such as nitromethane or alcohol) is allowed. Leaded fuel will not be allowed. Nitrous oxide or other oxidizing agents are not allowed. The M85-fueled cars must use the fuel mixture documented in the supplemental M85 rules. The host will provide fuel

for all the teams at the event. (Specifications will be sent to all competitors in mid-December).

The temperature of fuel introduced into the fuel system may not be changed with the intent to improve calculated fuel economy.

No agents other than fuel (gasoline or M85), and air may be induced into the combustion chamber. Non-adherence to this rule will be reason for disqualification. Officials have the right to inspect the oil. Only ambient air may be used to cool an intercooler.

3.4.3 Fuel System

All gasoline fueled cars must be equipped with a fuel tank having a volume of no more than 7.5 liters (2 U.S. gallons). M85 fueled cars must be equipped with a fuel tank having a volume no greater than 13 liters (3.5 U.S. gallons). The fuel system must have a provision for emptying the fuel tank for the purpose of measuring the tank volume. Any size tank may be used up to the maximum allowable size.

All fuel tanks must have a filler neck of at least **30 mm (1.2 inches)** diameter and at least 80 mm (3.2 inches) vertical height. This 80 mm of vertical height must be above the top level of the tank, and must be accompanied by a fuel resistant **clear** sight tube for reading fuel level (figure 7). **The sight tube may not be run from the bottom of the fuel tank. A clear filler tube may be used, subject to approval by the rules committee or technical inspectors at the event. A permanent, non-moveable** fuel level line must be located between 13 mm and 25 mm (0.5 inch and 1 inch) **below the top of the sight tube.** When filled to this level, the fuel system, including fuel lines, filters, etc., must not hold any more than the maximum allowable fuel volume. **The tank must be capable of being filled to capacity without manipulating the tank or vehicle in any way (shaking vehicle, etc.).** The sight tube must be clearly visible to an individual filling the tank.

FIGURE 7

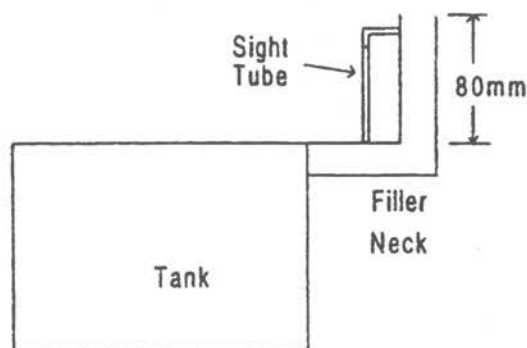

The fuel system must be designed such that the spillage during refueling cannot contact the driver position, exhaust system or hot engine parts, or the ignition system. Belly pans must be vented to prevent accumulation of fuel.

The fuel tank and carburetor venting systems must be designed such that fuel cannot spill during hard cornering or acceleration. This is a concern since motorcycle carburetors normally are not designed for lateral accelerations. During the inspection, the car must be capable of being tilted to a 45 degree angle without fuel spilling from the carburetor or full gas tank. All fuel vent lines must be equipped with a check valve to prevent fuel leakage when the tank is inverted. All fuel vent lines must exit outside the bodywork.

High pressure over 103.4 kPa (15 psi) fuel systems must utilize protected hose (metal braided or some other abrasion resistant shielding) with either threaded fittings or modern OEM type fittings used without modifications to either the hose or the fitting. Hose clamps over removable line of any type is not permitted on high pressure fuel line. Fuel lines must be securely attached to the vehicle and/or engine. All fuel lines must be protected from possible rotating equipment failure.

In order to prevent hazards in the case of a roll-over or collision, all parts of the fuel storage and supply system, and all parts of the engine air and fuel control systems that affect power (including the throttle or carburetor, but excluding air cleaner systems) must lie within the surface defined by the top of the roll bar and the outside edge of the four tires (see figure 8). All fuel tanks must lie within the major structure of the chassis.

FIGURE 8

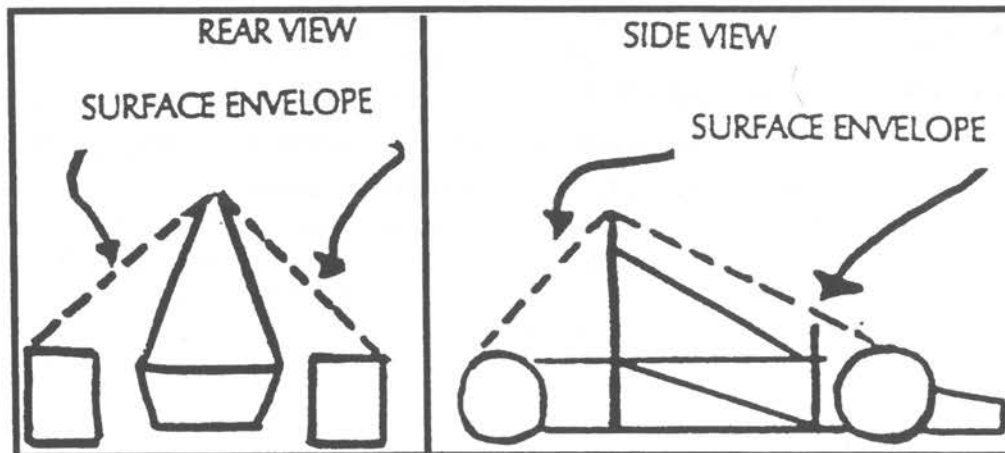

3.4.4 Throttle and Intake Restrictor

The car must be equipped with a carburetor or throttle body. The carburetor or throttle body may be of any size or design. The throttle cable must have smooth operation and must not have the possibility of binding or sticking. The throttle actuation system must use two independent springs to close the throttle such that the failure of one spring cannot effect the performance of the other spring. Throttle cables must be at least 50 mm (2 inches) from any exhaust system component and out of the exhaust stream. The use of a push-pull type throttle cable with a throttle pedal that is capable of forcing the

throttle closed (e.g. toe strap) is recommended. A positive pedal stop must be incorporated on the throttle pedal to prevent over stressing the throttle cable or actuation system.

In order to limit the power capability from the engine, a single circular restrictor must be placed in the intake system between the throttle and the engine and all engine air flow must pass through the restrictor. Any device that has the ability to throttle the engine downstream of the restrictor is prohibited. The diameter of the restrictor must be no larger than 20 mm (0.7874 inch) for gasoline-fueled cars and 18 mm (0.7087 inch) for M85-fueled cars. The restrictor must be located to facilitate measurement during the inspection process. If the throttle exit (not venturi) or intake manifold (of a single tube through which all flow passes) has a diameter of equal or smaller than the restrictor, then a restrictor is not required.

Turbochargers or superchargers are allowed if the competition team designs the application. Engines that have been designed for and originally come equipped with a turbocharger are not allowed to compete with the turbo installed. The restrictor must be placed upstream of the compressor but after the carburetor or throttle valve. **Thus, the only sequence allowed is throttle, restrictor, compressor, engine.**

3.4.5 Muffler and Exhaust System

ISSUE — THE EXACT PLACEMENT OF THE MICS. ARE NOT SPECIFIED IN THIS SECTION — I.E. DISTANCE FROM THE LINE TO THE MIC. LINE. —

The car must be equipped with a muffler in the exhaust system to reduce the noise to an acceptable level. The noise level will be measured with a sound level meter as the car accelerates at full power along a straight line for a distance of 30 m (98 feet). The measurement is made at the midpoint of the run at a distance of **7.5 m (24.6 feet)** from the centerline of the track, 1 m (3 feet) above the ground. The sound level meter will be set on RMS DETECTION, FAST TIME WEIGHTING, A-WEIGHTING. The sound level must not exceed **98 dBA** at any time during the test. **The noise level will be tested prior to the dynamic events, and will be measured during all dynamic events.** A DNF will be awarded for the runs on which the sound test was failed. For the endurance event, each noise violation will result in the assessment of a 2 cone penalty. The exhaust must be routed so that the driver is not subjected to fumes at any speed considering the draft of the car.

3.5 General

3.5.1 Car Number

Each car will receive a number at the time of its entry in the competition. This number must be displayed in 15.24 cm (6 inch), or larger, characters on a contrasting background that are clearly visible from both sides of the car.

The top ten numbers are reserved for the top ten finishers from the previous year's competition.

3.5.2 Aerodynamics and Power Ground Effects

The purpose of the following rules is to minimize any likelihood of injury to spectators, officials, driver, etc. in the case of accidental contact with the wings and structure:

- 3.5.2.1 The wing or wings must be located in plan view within a quadrilateral defined by the outside of the tires on the sides, by a transverse line 460 mm (18 inches) in front of the fronts of the front tires, and by a transverse line between the rear of the rear tires.
- 3.5.2.2 Egress from the vehicle within the time set in section 3.3.7 shall not require any movement of the wing or wings or their mountings. The wing or wings must be mounted in such positions, and sturdily enough, that any accident is unlikely to deform the wings or their mountings in such a way to block the drivers egress.
- 3.5.2.3 All wings: leading edges shall have a minimum radius 12 mm (0.5 inch) unless a wing projects in front of the front of the front tires, in which case it must have a minimum radius of 19 mm (0.75 inch). Wing leading edges must be as blunt or blunter than the required radii for an arc of plus or minus 45 degrees centered on a plane parallel to the ground or similar reference plane for all incidence angles which lie within the range of adjustment of the wing or wing element. If leading edge slats or slots are used both the fronts of the slots or slats and of the main body of the wings must meet the minimum radius rules.
- 3.5.2.4 All wing edges, end plates and wing accessories must have minimum edge radii of at least 3 mm (1/8 inch) e.g., this would mean at least a 6 mm (1/4 inch) thick edge.
- 3.5.2.5 No small radius edges may be included anywhere on the wings in such a way which would violate the safety intent of these rules (i.e. vortex generators with thin edges, sharp square corners on end plates, etc.).
- 3.5.2.6 No power device may be used to move or remove air from under the race car except fans designed exclusively for cooling. No power ground effects are allowed.

3.5.3 Modifications

Modifications to the car are not allowed after the inspection and engineering judging except as noted below. This includes modifications that affect the available gear ratios, power transfer system, or safety. The removal of body panels for weight reduction is not allowed. Adjustments (e.g., tire pressure, brake bias, suspension adjustments, wing angle, and chain or belt tension) are allowed to the car after the start of the performance events. Necessary repairs

are allowed under the knowledge of the Faculty Advisor and the car must pass a re-inspection by the inspection judges.

3.5.4 Fasteners

All bolts utilized in the steering, braking, safety harness and suspension systems must meet SAE Grade 5, Metric Grade M 8.8 and/or AN/MS specifications. All critical bolt, nuts, and other fasteners on the steering, braking, safety harness, and suspension must be secured from unintentional loosening. This can be accomplished best with safety wiring or cotter pinning; however, nylon lock nuts, locktight, and other forms deemed appropriate by the judges will be considered. Rod ends on the steering or suspension must be in double shear or captured by having a bolt head or washer larger than the diameter of the spherical bearing. Adjustable tie-rod ends must be constrained with a jam nut to prevent loosening.

3.5.5 Body and Styling

The vehicle must be open-wheeled and open-cockpit (a formula style body.) ***To protect the driver, there shall be no openings thru the bodywork into the driver compartment from the front of the vehicle back to the roll bar main hoop or firewall other than that required for the cockpit opening. Minimal openings around the front suspension components are allowed.***

3.5.6 Wheelbase and Vehicle Configuration

The car must have a wheel base of at least 1520 mm (60 inches). The wheel base is measured from the center of ground contact of the front and rear tires with the wheels pointed straight. The vehicle must have four wheels that are not in a straight line.

3.5.7 Flags

The flag signals convey the commands described below, and shall be obeyed immediately and without question.

Flagging for Formula SAE®

There are two kinds of flags for the competition: Command flags and Informational flags. Command flags are just that, flags that send a message to the competitor that the competitor must obey without question. Informational flags, on the other hand, require no action from the driver, but should be used as added information to help him or her to maximize performance. What follows is a brief description of what each flag means for this competition.

COMMAND FLAGS

YELLOW FLAG (Stationary)

Danger, SLOW DOWN, be prepared to take evasive action, something has happened beyond the flag station. NO PASSING unless directed by the corner workers.

(Waved)

Great Danger, SLOW DOWN, evasive action is most likely required, BE PREPARED TO STOP, something has happened beyond the flag station, NO PASSING unless directed by the corner workers.

BLUE FLAG (Blue w/Yellow diagonal stripe)

Pull into the designated passing zone to be passed by a faster competitor. Obey the corner workers hand signals at the end of the passing zone to safely merge into competition.

RED FLAG

Come to an immediate safe controlled stop on the course. Pull to the side of the course as much as possible to keep the course open. Follow corner worker directions.

BLACK FLAG

Pull into the penalty box for discussion with the Director of Operations or other official concerning an incident of course. A time penalty may be assessed at this time.

BLACK FLAG WITH ORANGE DOT

Pull into the penalty box for a mechanical inspection of your car, something has been observed that needs closer inspection.

GREEN FLAG

Your session has started, enter the course under direction of the starter. (NOTE: If you stall the vehicle, please restart and await another green flag as the opening in traffic may have closed.)

CHECKER FLAG

Your session has been completed. Exit the course at the first opportunity.

INFORMATIONAL FLAGS

RED AND YELLOW STRIPED FLAG

Something is on the racing surface that should not be there. Be prepared for evasive maneuvers to avoid the situation. (Corner workers may be able to point out what and where it is located, but do not expect it.)

WHITE FLAG

There is a slow moving vehicle on the course that is much slower than you are. Be prepared to approach it at a cautious rate.

Penalties and Assessed Times or Disqualifications:

Failure to Yield at Flag	1 Minute
Over Driving (After a Closed Black Flag)	1 Minute
Passing Under the Yellow Flag	2 Minutes
Mechanical Problem	Time Needed for car inspection by SCCA Tech Inspector
VEHICLE TO VEHICLE CONTACT	DISQUALIFIED

4. COMPETITION

The competition is divided into two categories:

- 1) **STATIC EVENTS:** Inspection, design, presentation and cost.
- 2) **DYNAMIC EVENTS:** Acceleration, skid pad, autocross, fuel economy and endurance.

Each of these events is described below in terms of the concept, how the event is conducted, the criteria used in judging, and the formula for scoring.

The host reserves the right to alter the conduct and scoring of the competition based on weather conditions. A predefined policy for handling such disruptions will be published prior to the competition.

An individual team member cannot drive in more than three events. Fuel economy event is considered a separate event although it is conducted simultaneously with another event. An individual may not drive in both heats of any event. It is the team's option to participate in any event. The team may forfeit their second heat in any performance event.

4.1 Inspection

The concept of the inspection is to insure that the safety and design requirements outlined in the rules have been met. For cases in which the rules are not perfectly clear, the intent of the rule must be met. Violation of the intent of the rule is considered a violation of the rule.

Vehicle inspection will be performed at the time specified in the competition schedule. In addition to the general inspection, the following specific tests will be conducted:

- Brake Check
- Sound Level
- Intake Orifice Diameter
- Roll Over Stability (57 degree Tilt Test)

- Fuel Leakage Test (45 degree Tilt Test)
- Wing and end plate radii

The judges will complete the Safety and Technical Inspection, the Fuel Capacity and Tilt Table Inspection and the Noise Level and Braking Performance Inspection Check-lists in the **Appendix as A-2**. If the judges find any part of the car that does not comply with the rules or is deemed to be a safety concern, then the team must correct the problem and request a reinspection before the car is allowed to compete in any performance event. The inspection judges reserve the right to reinspect any of the specifications (particularly the brakes and muffler) at any time during the competition.

The inspection is not scored for team points; however, the car must pass the inspection and remain in accordance with the rules before it is allowed to compete.

4.2 Cost Event

The concept of the cost event is to obtain an accurate estimate of the cost of the car in limited production. This evaluates not only the actual cost of the car, but also the team's ability to prepare an accurate engineering cost estimate. The car with the lowest corrected cost and the best report will win the event.

Staying within a given budget is critical to the success of any "real life" engineering project (even professional race teams have finite budgets). Designing a great product that is over budget does not translate into a job well done. As such, the cost scoring has been devised to stress this important aspect of engineering and to appropriately reward or penalize teams according to how they manage a budget. (Designing a great mousetrap is not nearly the challenge of designing the best mousetrap for a given amount of money.)

The deadline for submitting cost reports is April 1, 1999. The reports should be mailed to: ***Attn: Suzy Zukowski, Team FSAE™ - Chrysler Corporation, CIMS 483-01-14, 800 Chrysler Dr., Auburn Hills, MI 48326-2757.*** It is imperative that the cost judges have the cost reports in enough time for proper evaluation. **Teams that submit reports late will be penalized -25 points per day late with a maximum penalty of -375 points.** Teams that do not submit a cost report will receive -400 points for the Cost Score. The team must present their vehicle at the designated time to the cost judges for review of the cost report.

The cost report review schedule will be posted at the organizational meeting on the first day of the competition. Amendments that reflect any changes made after submission of the cost report must be submitted at registration. The amendment document must follow the template format specified in **Appendix A-3. No other format will be accepted at registration.**

The cost event is judged on the basis of the cost of the car and the quality of the cost report. The cost of the car is determined by the cost of the parts and fabrication for a production rate of 1000 cars per year using established manufacturing practices.

The team will prepare a detailed engineering cost analysis using the guidelines given in **Appendix A-4 and A-5**. From this analysis, the cost judges will determine if all parts and processes were included in the analysis and if unreasonably low (determine by the experience of the judges) costs were used. In the case of any omission, error, or cost below reasonable estimates are used, then the judges will add a penalty equal to twice the cost error. The competitors price plus penalties will be used to determine the cost score.

For example, if a car has tires listed at \$10 and the Cost Judges have evidence that the same or similar tires should actually cost \$50 then the judges add $2 \times \$40$ for each tire to the cost. Errors of costs above reasonable estimates are not penalized further, and the error is not corrected. Cost reports that have not made a serious attempt at an accurate estimate or that claim that their cost is substantially below what the Cost Judges know to be appropriate for cars of this type will be disqualified as unresponsive and will be scored as unsubmitted.

The score is the sum of the report score and the price score. The report score will be given based upon the quality of the cost report. The range for the report score will be 0-25. The price score will be awarded based upon the following formula:

$$\text{PRICE SCORE} = 75 * (\$9000 - P_{\text{your}}) / (\$9000 - P_{\text{min}}) \text{ for } P_{\text{your}} \leq \$9000$$

$$\text{PRICE SCORE} = 150 * (\$9000 - P_{\text{your}}) / (\$9000 - P_{\text{min}}) \text{ for } P_{\text{your}} > \$9000$$

$$\text{COST SCORE} = \text{Price Score} + \text{Report Score}$$

P_{your} is the adjusted cost of your car (with penalties), and P_{min} is the adjusted cost of the lowest cost car. Note: \$9000 is the maximum price of your car above which negative points are awarded. Cars accurately priced below \$9000 are awarded positive price score points up to 75; however, the price score will be limited at -300 points.

The cost analysis for the car is based upon the estimated cost for materials, fabrication, and assembly of a car in limited production (1000 cars per year). The engineering cost estimate may have little relationship to the actual money spent for the prototype. The cost analysis should consider fabrication techniques that would be used in the 1000 car per year limited production run. The actual production technique must be used on the prototype if at all feasible (e.g., cast parts should be cast on the prototype, etc.). Further, the parts used in the cost estimate must be the actual parts used on the prototype and substitution of cheaper parts for the cost analysis is prohibited. For example, if styled wheels costing \$150 each are used on the prototype, then substitute wheels costing \$50 each cannot be used in the cost analysis.

MANDATORY REPORT FORMAT:

The cost of the car must be itemized into subassemblies and follow the format in **Appendix A-5**.

RECEIPTS:

Parts and materials used in the car are estimated based upon wholesale supplier's quotes. The receipts should be numbered, labeled, and attached to each sub-assembly section in the quantities stated. If a wholesale price is not available, then sixty (60) percent of retail can be used; however, actual suggested retail cost must be documented since some so-called retail costs actually includes substantial discounts. Hand written receipts will be considered as wholesale costs unless "RETAIL" is written on the receipt and Cost Judges are able to verify the amount by calling the listed retailer. The supplier/retailer's phone number must be included with each receipt. Costing based upon, and the use of, used parts in production is not permitted.

PROCESS COSTS:

The time required to load, unload, assemble, manually machine (as opposed to CNC) paint, fabricate, etc. is costed at \$35/hour if it is not explicitly costed from the Operations Cost Table. Do not include overhead costs of expendables, capital costs and depreciation of machine equipment. The table given on the next page provides some guidelines to the cost of various operations.

HINT: It may be helpful to your team to make "process flow charts" which organize the fabrication and assembly of your car to accurately identify all of the costs of production. These flow charts are not required in the cost report.

The car will be considered to be shipped as primed or gel coated and a cost recorded. Any finishes (paint, polish, etc.) which are only used to beautify need not be costed. Preservative finishes intended to protect the appearance or function of a component for an extended period of time must be costed (labor and material included).

The cost of the engine depends upon the performance rating of the engine and whether it is equipped with an integral transmission. The engine performance rating is based upon the power potential of the manufacturer's specification of the engine without restrictor modification. The engine is considered low performance if it is capable of producing less than 5 horsepower per 100 cc displacement (industrial engines, etc.). A high performance engine is capable of 5-10 horsepower per 100 cc (normal motorcycle engines with 2-valves per cylinder, etc.).

An ultra high performance engine is capable of more than 10 horsepower per 100 cc (new high-tech engines, 3 or 4-valves per cylinder, etc.). The engine is considered to be purchased with all of the required components and systems necessary to run except the carburetor (or fuel injection system), the ignition and/or electrical system (including spark plug(s)), turbo or supercharger if used, the intake manifold, the exhaust manifold, cooling system, and mufflers. These costs must be listed separately in the cost analysis. The following table lists the cost of the engine (without intake and exhaust systems):

RATING	WITHOUT TRANSMISSION	WITH INTEGRAL TRANSMISSION	WITH TURBO or SUPER CHARGER
Low	\$0.35/cc	\$0.60/cc	additional \$600.00 per engine
High	\$0.75/cc	\$1.00/cc	
Ultra-high	\$1.00/cc	\$1.25/cc	

Engines that come equipped with an integral transmission, differential, and U-jointed axles must estimate the cost of the differential and U-joints separately.

The following table must be used in estimating costs:

OPERATIONS COST TABLE	
Labor (All activity)	\$ 35.00/hr
CNC Machining (Time)	\$ 70.00/hr
Welds	\$ 0.14/cm (0.35/inch)
Saw or tubing cuts	\$ 0.16/cm (0.40/inch) diameter
Tube bends	\$ 0.75/bend
Non-metallic cutting	\$ 0.08/cm (\$0.20/in)
Tube end preparation for welding	\$ 0.75/end
Drilled hole less than 1" dia., any depth	\$ 0.35/hole
Drilled hole greater than 1" diameter	\$ 0.35/inch/hole
Reamed hole	\$ 0.35/hole
Tapping holes	\$ 0.35/hole
Sheet metal shearing	\$ 0.20/cut
Sheet metal punching	\$ 0.20/hole
Sheet metal bends	\$ 0.05/bend
Sheet metal stampings (process cost only)	\$ 0.008/cm ² (0.05/sq. inch)
Sand castings (process cost only)	\$ 6.61/kg (3.00/pound)
Die castings (process cost only)	\$ 8.82/kg (4.00/pound)
Investment Casting (process cost only)	\$ 17.64/kg (\$8.00/pound)
Plastic injection molding (process cost only)	\$ 6.06/kg (2.75/pound)

Costs for composites and structural construction similar to fiberglass should be costed separately with a **clear identification of the costs of all material and processes.** As a minimum, material costs only of \$88.18/kg (\$40/pound) is expected for non-graphite composites, and \$220.5/kg (\$100/pound) minimum is expected for graphite-based composites. All material costs must be documented with receipts based on a 1000 car per year production run. Obviously, process costs are in addition to these material cost minimums.

4.3 Presentation Event

The concept of the presentation event is to evaluate the team's ability to make a presentation to the customer. ***The presentation should address the "Concept of the Competition" as described on page #1, and should convince the customer of the superiority of the team's design.*** The presentation judges will evaluate the organization, content, and delivery of the presentation. The team that makes the best presentation (regardless of the quality of the car) will win the event.

Presentation will be made on the first day of the event. The presentation time will be randomly selected and will be posted in conjunction with the organizational meeting held

in the morning. A team will receive zero (0) presentation points if they fail to make their presentation during the allotted period.

One (or more) team member(s) will give the presentation to the judging team. The host will provide details regarding the presentation in the newsletter. The presentation cannot last more than 10 minutes and should not be interrupted by questions. After the presentation, there will be approximately 5 minutes of questions. Only judges are permitted to ask questions. The audience may not ask questions or make any comments or distractions. During the question period, team members are encouraged to answer questions.

The presentation judges will consider the content, organization, and delivery of the presentation and will only evaluate the team's ability to give a presentation. The judges will use the judging form given in **Appendix A-6**.

The scoring of the event is based on the average of the two or three presentation judging forms. There is a maximum of 50 points from the Presentation Judging Form.

$$\text{PRESENTATION SCORE} = 75 * P_{\text{your}}/P_{\text{max}}$$

It is intended that the scores will range from near zero (0) to seventy-five (75) to provide good separation.

4.4 Design Event

The concept of the design event is to evaluate the engineering effort that went into the design of the car and how the engineering meets the intent of the market. The car that illustrates the best use of engineering to meet the design goals and the best understanding of the design by the team members will win the design event.

Judging will start with a pre-event Design Review submitted at least 1 month before the event. This review should be a maximum of four pages in length. The review should contain a brief description of the vehicle with a discussion of any important design features and vehicle concepts. Include a list of different analysis and testing techniques (FEA, Dynamometer testing, etc.). Evidence of this analysis and back-up data should be brought to the competition and be available, on request, for review by the judges. This pre-event review will be used by the judges to sort teams into the appropriate design groups based on the quality of their review.

- ➔ TEAMS WHO DO NOT SUBMIT A PRE-EVENT**
- ➔ DESIGN REVIEW ON TIME WILL NOT**
- ➔ COMPETE IN THE DESIGN EVENT, AND WILL**

➔ RECEIVE ZERO POINTS FOR DESIGN.

Teams that submit a review, but are deemed to be unsatisfactory, will also not compete in the design event, but will receive between 5 and 20 pts. for their efforts.

REVIEWS SHOULD BE IN BLACK & WHITE AND EASILY READABLE ONCE FAXED.

Pre-event Design Reviews must arrive at SAE International no later than April 20, 1999. Send Design Reviews to Shanin Hart, SAE Int'l, 400 Commonwealth Drive, Warrendale PA 15096-0001, E-mail: hart@sae.org or fax: 724-776-0890. Mail and e-mail reviews are preferred, although faxed reviews will be accepted.

The design event consists of an informal question and answer session between the team and the design judges. The design judges are encouraged to ask penetrating questions relative to the team's understanding and level of analysis of the car. Examples of questions are: stress levels, frame stiffness, Ackerman angles, bump steer, weight distribution, suspension curves, roll centers, rationale for design tradeoffs, etc.

The design judges will evaluate the engineering effort based upon the team's responses to questions and an inspection of the car. The design judges will inspect the car to determine if the design concepts are adequate and appropriate for the application (relative to the objectives set forth in the rules). It is the responsibility of the judges to deduct points on the design judging form as given in **Appendix A-7** if the team does not understand the engineering and construction of the car.

The actual format of the design event may change from year to year as determined by the organizing body. The event will normally involve three parts: initial judging of all vehicles by 5 to 7 judging teams, semi-final judging of the top 15 to 20 vehicles by 5 to 10 individual judges, final judging ranking the top 4 to 8 vehicles.

Scoring will be from 0 to 150 pts. At the judges discretion.

All teams should provide photos of their vehicle upon entering the design tent. These photos should show the basic design of the major components. A total of four photos are recommended. These photos are to aid the judges in selecting semi-finalists and are not the photos which will be used for yearly documentation. **Teams not providing these photos will not progress to the design semi-finals. Polaroids are acceptable.**

The scores should range from zero (0) to one-hundred fifty (150) to provide good separation.

4.5 Acceleration Event

The acceleration event evaluates the car's acceleration in a straight line on flat pavement.

There will be two heats. Each heat must have a different driver and each driver can have two runs. Starting order will be based upon time of arrival to the staging area. Heat 1 and 2 will not be run sequentially, but simultaneously. Heat 1 drivers will have starting priority over heat 2 drivers.

The cars will accelerate from a standing start over a distance of 100 yards on a flat surface. The cars will be staged .30 m (11.8 inches) behind the starting line. A green flag will be used to indicate the approval to begin, however, the timers start only after the front tires cross the start line. There will be no particular order of the cars in each heat. A driver has the option to take a second run immediately after the first.

Special agents that increase traction may not be added to the tires or track surface and "burnouts" are not allowed. Cars that have not run by the end of the event (determined by the host) will receive a DNF.

The acceleration score is based upon the corrected elapsed time. Elapsed time will be measured from the time the car crosses the starting line until it crosses the finish line. A two (2) second penalty will be added for each DOO (including entry and exit gate cones). An OC will result in a DNF for that run.

The score for the acceleration event is spread between zero (0) and seventy-five (75) based upon the elapsed time. The following equation is used to determine the scores for the event:

$$\text{ACCELERATION SCORE} = 75 * \frac{(6.5/T_{\text{your}}) - 1}{(6.5/T_{\text{min}}) - 1}$$

DNF = zero (0) points. The minimum acceptable acceleration time is 6.5 seconds corresponding to an average speed of 50.6 km/hr. Negative points will not be given. T_{min} will be the elapsed time of the fastest car.

4.6 Skid-Pad Event

The concept of the skid-pad event is to measure the cornering ability of the car on a flat surface while making a constant-radius turn.

Each car may compete in two heats. Each heat must have a different driver and each driver can have two runs. There will be no particular order of the cars in each heat. Immediately following a run, the driver has the option of entering the front of the line to take a second run.

There will be no distinction between heat one (1) and two (2) and there will be no particular starting order. Heat one (1) drivers will have starting priority over heat two (2) drivers. Cars which have not run by the event closing (determined by the host) will receive a DNF for the event.

There will be two circles of 15.25 m (50.03 feet) diameter in a figure eight pattern. The circle centers will be separated by 18.25 m (59.88 feet), and a driving path 3.0 m (9.84 feet) in width will be marked with pylons and a chalk line just outside the pylons. The start/stop line is defined by the centers of the two (2) circles. A lap is defined as traveling around one (1) of the circles from the start/stop line and returning to the start/stop line.

The cars will enter perpendicular to the figure eight and will take one full lap on the right circle to establish the turn. The next lap will be on the right circle and will be timed. Immediately following the second lap, the car will enter the left circle for the third lap. The fourth lap will be on the left circle and will be timed. Immediately upon finishing the fourth lap, the car will exit the track. A driver has the option to take a second run immediately after the first. The car will exit at the intersection moving in the same direction as entered.

Sixteen (16) pylons will be placed around the inside of each circle and sixteen (16) around the outside of each circle. Additional pylons will establish the required entry and exit gates. Also, a cone will be placed in the middle of the exit gate to prevent drivethroughs until the finish lap.

The elapsed time for the right and left circle will be averaged together after the following penalties have been assessed:

- A penalty of 0.1 second will be added to the time for every cone that is knocked down or out (including gate cones).
- A DNF will be awarded for an off course. Cars that spin-out can continue as long as they have not gone off course.

The skid-pad score is computed based upon the lateral acceleration capability. Lateral acceleration is computed from $2.012 \text{ diameter}/t^2$. A diameter of 17.10 m will be assumed in computing lateral G's. T_{your} will be the average of the left and right timed laps on your best run including penalties. The following equation is used to determine the scores for the skid-pad event:

$$\text{SKID-PAD SCORE} = 50 * \frac{(6.184/T_{\text{your}})^2 - 1}{(6.184/T_{\text{min}})^2 - 1}$$

The minimum acceptable lateral acceleration is 0.90 G's corresponding to 6.184 seconds per circle. T_{min} will be the elapsed time of the fastest car. Negative points will not be given.

4.7 Autocross Event

The concept of the autocross event is to evaluate the car's maneuverability and handling qualities on a tight course without the hindrance of competing cars. The autocross course will combine the performance features of acceleration, braking, and cornering into one event.

There will be two Autocross-style heats, with each heat having a different driver. There will be no particular order of the cars to run each heat but a driver has the option to take a second run immediately after the first. Two (2) timed laps will be run (weather and time permitting) by each driver and the best lap time will stand as the time for that heat. The host will determine the allowable windows for each heat and retains the right to

adjust for weather or technical delays. Cars that have not run by the end of the heat will be disqualified for that heat.

The following specifications will suggest the maximum speeds that will be encountered on the course. Average speeds should be 40 km/hr (25 mph) to 48 km/hr (30 mph).

- Straights:** No longer than 60 m (200 feet) with hairpins at both ends (or) no longer than 45 m (150 feet) with wide turns on the ends.
- Constant Turns:** 23 m (75 feet) to 45 m (148 feet) diameter.
- Hairpin Turns:** Minimum of 7 m (23 feet) OD.
- Slaloms:** Cones in a straight line with 7.62 m (25 feet) to 12.19 m (40 feet) spacing.
- Miscellaneous:** Chicanes, multiple turns, decreasing radius turns, etc. The minimum track width will be 3.5 m (11.5 feet).

The length of each run will be approximately 0.805 km (1/2 mile) and the driver will complete a specified number of runs. The time required to complete each run will be recorded and the time of the best run will be used to determine the score.

The cars are judged on elapsed time plus penalties. The following penalties will be added to the elapsed time:

- Two (2) seconds per DOO
- For an OC, the driver must re-enter the track at or prior to the missed gate or a 20 second penalty will be assessed.

Penalties will not be assessed for accident avoidance or other reasons deemed sufficient by the track official.

If a car stalls and cannot restart itself, then the track workers will attempt to push start the car at their discretion. Cars deemed disabled will be cleared from the track by the track workers. At that time, two (2) team members may retrieve the car to the paddock. The track workers will signal for more team members as required.

Elapsed time plus penalties will be used as the corrected elapsed time. Cars that are unable to complete the course with an average speed of 80% of the fastest car will not be awarded points. This means that any autocross time in excess of 125% of the fastest time will receive no points. Negative points will not be given.

The following equation is used to determine the autocross score:

$$\text{AUTOCROSS SCORE} = \frac{(T_{\max}/T_{\text{your}}) - 1}{(T_{\max}/T_{\min}) - 1} * 150$$

T_{\max} will be equal to 125% of T_{\min} . T_{\min} will be the lowest corrected elapsed time recorded for any competitor in either heat. T_{your} will be the lowest corrected elapsed time of either heat for the team being scored.

4.8 Endurance Track and Fuel Economy Event

The following are general guidelines for conducting the endurance and fuel economy events. The host reserves the right to establish procedures specific to the conduct of the event at the location. All such procedures will be made known to the teams through newsletters.

In order to compete in the first heat of endurance, a team must have scored points in at least two of the three preceding dynamic events. There are no pre-qualification requirements for the second heat of endurance.

The Endurance Event is designed to evaluate the overall performance of the car and to test the car's reliability. The event will be run as the best of two heats, teams will not be allowed to work on their vehicles during a heat. During each heat there will be a three minute driver change, but no refueling will be permitted during each heat. If a vehicle breaks down it will be removed from the course and will not be allowed to re-enter the course (if a vehicle stalls, or ingests a cone, etc., it will be allowed to restart and re-enter the course where it went off, but no mechanical work may be performed on the vehicle). The team may still receive full points for the endurance event by finishing the other heat. This will save time and decrease the complexity of the endurance event.

The car's fuel economy will be measured in conjunction with the endurance event. The fuel economy under racing conditions is important in most forms of racing and also shows how well the car has been tuned for the competition. This is a compromise event because the fuel economy score and endurance score will be calculated from the same heat. No refueling will be allowed during an endurance heat.

During fueling, once filled to the scribe line, no shaking or tilting of the tank or fuel system (incl. entire vehicle) is allowed.

Course speeds can be estimated by the following course specifications. Average speed should be 48 km/hr (29.8 mph) to 57 km/hr (35.4 mph) with top speeds of approximately 105 km/hr (65.2 mph).

Straights:	No longer than 77 m (252.6 feet) with hairpins at both ends (or) no longer than 61 m (200.1 feet) with wide turns on the ends. There will be passing zones at several locations.
Constant Turns:	30 m (98.4 feet) to 54 m (177.2 feet) diameter.
Hairpin Turns:	Minimum of 9 m (29.5 feet) OD.
Slaloms:	Cones in a straight line with 9 m (29.5 feet) to 15 m (49.2 feet) spacing.
Miscellaneous:	Chicanes, multiple turns, decreasing radius turns, etc. The minimum track width will be 4.5 m (14.76 feet).

The standard format will be two 22 km (13.66 mile) heats. In the event that weather or facility size precludes the running of two 22 km (13.66 mile) heats, then, one 22 km heat will be run with one driver change. Two 11 km heats each with driver changes will NOT be an acceptable replacement as this significantly reduces the demanding nature of the continuous 22 km run. In the event that only one 22 km heat is run, only two drivers (not four) will be able to compete in the endurance event.

Each heat will consist of the following:

- The fuel tank will be filled to the mark. This must occur at the beginning of both heats. Teams may not start the second heat without first reporting to the refueling station.
- Elapsed time will begin as defined in the judging section. Driver A will drive 11 km, and pull into the driver change area.
- Driver A will exit the vehicle and any necessary adjustments will be made to the vehicle to fit driver B (seat cushions, pedal position, etc.). Other than the two drivers, only one team member will be allowed in the driver change area, and only the tools necessary to change drivers will be carried into this area (no tool chests etc.). Extra people entering the driver change area will result in a 20 pt penalty to the final endurance score for each extra person entering the area.
- Driver B will then be secured in the vehicle. Three minutes after entering the driver change area the vehicle will be allowed to re-enter the course. The driver change area will be placed such that the timing system will see the driver change as an extra long lap. Unless this driver change takes longer than three minutes, this extra long lap will not count. If the driver change takes longer than three minutes, the extra time will be counted into the final time.
- Driver B will drive 11 km, and elapsed time will stop when the car finishes.
- Driver B will proceed directly to the fueling station. The tank will be filled to refill mark and the amount will be recorded.

Cars will be allowed to enter the track based upon the current level of traffic on the course. From 5 to 7 vehicles will be allowed on the track at once. This includes any vehicles in the driver change area.

Since repairs will not be allowed during each heat, and there will be no refueling during each heat, there will not be a restart queue of any kind. This is one of the many simplifications which are being made in order to allow a return to two long endurance heats with our increasing number of vehicles.

The run order for both heats of the endurance event will be based off the results of the autocross event, with the fastest team first followed by the second fastest, etc. Teams will be expected to keep track of the run order and have their vehicle fueled and ready in time for their turn to run. If a team is not ready to start when their turn arrives (i.e. at the starting line, full of fuel and ready to start the vehicle), they will be penalized two minutes and be allowed to run at the end of the heat (time permitting). It is recommended that teams show up at the refueling station at least a half hour before each heat, as it will be the team's responsibility to be refueled on time to run.

If conditions (facilities and number of competitors) are such that it is not possible to conduct two 22 km heats, then as many vehicles as possible will be allowed to run a

second heat. This is necessary given the growth of the event. The intent is to assure the most competitive event for the most well prepared teams (i.e. teams in the top 20 or 30 in the autocross should get to run in both heats).

If a car experiences a breakdown, or is unable to maintain lap times within 133% of the fastest lap time for the course, then it must exit immediately. If the car stalls and cannot be restarted, then the track workers will push the car clear of the track. At that time, two team members may retrieve the car under direction of the track workers. No work may be performed on the vehicle while it is in the track area.

Vehicles must power down after leaving the course and be pushed into and out of the fueling area.

Fuel pumps will be turned on and fuel valves will be opened to insure complete refueling.

Each lap of the endurance event will be individually timed either by electronic means, or by hand. The time for an individual heat will be determined by subtracting the extra long lap for the driver change from the total time and adding any penalty points.

The following penalties will be assessed:

- Any aggressive driving behavior (such as forcing another car off the track, refusal to allow passing, or close driving that would cause the likelihood of car contact) will result in a black flag for that driver. When a driver receives a black flag signal, he must proceed to the penalty box to listen to a reprimand for his driving behavior. The amount of time spent in the penalty box will vary from zero to four minutes depending upon the severity of the offense.
- two (2) seconds per DOO
- For an OC, the driver must reenter the track at or prior to the missed gate or a twenty (20) second penalty will be assessed.
- The Chief Course Judge may disqualify a driver in the interest of safety if the driver is inexperienced or too aggressive, resulting in a DNF.
- two (2) minute penalty for not running in the correct order.
- two (2) minute penalty for having a corrected mileage worse than 26 liters/100km.

Penalties will not be assessed for accidental avoidance or other reason deemed sufficient by the track official.

Further driving rules and the meaning of flags are discussed in the Driving Rules section.

The score for the Endurance Track Event is the sum of the endurance time score and the endurance finish score. The endurance score is the sum of the time and finish score. The time score is calculated using the formula below. A car will receive an endurance score of fifty (50) if it completes the entire endurance event within the allotted window. The following equation is used to determine the scores for the event:

$$\text{ENDURANCE TIME SCORE} = 300 * \frac{(T_{\max}/T_{\text{your}}) - 1}{(T_{\max}/T_{\min}) - 1} + 50$$

The times for the endurance event will be based upon the sum of the times of each driver in a heat plus penalties. T_{\min} will be the lowest corrected time of the fastest team of the event in either heat. T_{your} will be the combined corrected times of the drivers in your best heat. Your best heat is the heat that gives the best combined scores of the endurance and fuel economy events. T_{\max} will be based upon an average speed of 75% of the fastest team of the event; therefore, T_{\max} will be 1.333 times T_{\min} .

The fuel economy score is based on the average liter per kilometer fuel economy obtained during the given endurance heat. Fuel economy will be calculated for both heats.

The volume of M85 fuel will be divided by a 1.75 correction factor to determine the gasoline equivalent volume. This correction factor is equal to the ratio of energy (lower heating value) per unit volume of gasoline to M85.

Fuel economy scores can range from zero (0) to fifty (50). The following equation will be used to determine the fuel economy score:

$$\text{FUEL ECONOMY SCORE} = \frac{(V_{\max}/V_{\text{your}}) - 1}{(V_{\max}/V_{\min}) - 1} * 50$$

V_{\max} will be set equal to 5.72 liters (1.51 gallons) and will be adjusted to represent 26 liters/100km (9.04 mpg) if the course is shortened. V_{\min} will be the smallest volume of fuel used by any competitor for the two heats. Vehicles which consume more than 5.72 liters of fuel during the course of an endurance heat will receive 0 pts. for fuel economy for that heat, and will also receive a penalty of 2 minutes on that heat.

For shortened courses, V_{\min} will be the low value per heat. In any case, the Fuel Economy and the Endurance score will be taken from the heat which yields the highest combined score.

The host reserves the right to impound any competitor immediately after the event to check engine displacement (method to be determined by the host) and restrictor size.

4.9 Rules of Conduct

The Formula SAE® event is a design engineering competition that requires performance demonstration of vehicles and is NOT a race. Engineering ethics will apply. In all events, violation of the intent of the rule will be considered a violation of the rule. Any perceived loopholes or potential problems should be identified in writing to the host. The host will then clarify the matter and advise all participants.

It is recognized that hundreds of hours of labor have gone into fielding an entry into Formula SAE®. It is also recognized that this event is an **"engineering educational experience"** but that it often times becomes confused with a high stakes race. In the heat of competition, emotions peak and disputes arise. Our officials are trained volunteers and maximum human effort will be made to settle problems in an equitable, professional manner.

In light of all this, however, unsportsmanlike conduct will not be tolerated. Any driver, crew member, faculty advisor or spectator who by their conduct detracts from the character of the event, or who abuses, threatens, or uses profane language to an official may be assessed a warning or penalty for unsportsmanlike conduct. A second violation may result in expulsion of the team from the competition. Warnings and penalties may be given by any official and will become record with the approval/concurrence of the chief steward/consortium.

4.9.1 General Rules

During the competition, alcoholic beverages are not allowed on any of the event location property.

Disruptive parties at the motel should be prevented by the Faculty Advisor.

Cleanup of trash and debris is the responsibility of the teams.

Personal cars and trailers must be parked in designated areas only. Only FSAE competition vehicles will be allowed in the track areas.

Any problems that arise during the competition will be resolved through the Operations Center and the decision will be final. All protests must be in writing and will be subject to a twenty (20) point protest bond. If the protest is denied, this amount will be deducted from the final score; if upheld no points will be deducted. Protests must be filed within one hour after scores are posted.

It is the responsibility of teams to be in the right place at the right time. If a car is not ready to compete at the scheduled time, then the team forfeits the run of the event and will not be offered a late make-up. **The driver for an event will be disqualified if he does not attend the driver meeting for the event.**

4.9.2 Pit Rules

When the car is driven anywhere but the practice area or the competition tracks, the car must be driven at a walking pace. Whenever at all possible, a team member must walk beside the car at a normal walking pace. Cars with wings are required to have two team members walking on either side of the vehicle whenever the vehicle is in motion. During the performance events when the excitement is high, it is particularly important that the car be driven at a very slow pace in the pits; the walking rule will be enforced and point penalties will be assessed for violations of this rule.

Smoking is prohibited in all competition areas. The team's work area should be some defined area and should be kept uncluttered. At the end of the day, each team will clean all debris from their area and help with maintaining a clean paddock.

All refueling must be conducted by race officials.

SEE SCCA
19.4 → 19.7

If the protest is
well founded no
penalty will be
deducted even if
the protest is not
upheld.

Protests which
are judged to be
trivial will be
penalized.

4.9.3 Driving Rules

Cars must drive at a walking pace when going from one area to another with a team member walking beside the car. **The driver must be wearing a helmet, eye protection, and safety harness whenever the car is being driven under its own power.**

Practice for the endurance track event may be provided at the discretion of the host. Practice on any of the other performance tracks will not be allowed. A practice area may be provided in order to test and tune the cars. The practice area will be supervised and the number of cars in the area will be controlled. The cars may not be driven fast anywhere except the practice area and during the actual events. Off-course practice or any fast driving will be prohibited while competition events are in progress. The competition cars are prohibited from driving at any time (day or night) other than official competition or in the supervised practice areas. Unauthorized testing will result in point penalty from the competition officials. Officials will give only one warning to any team.

The safety of this competition and especially the endurance track event will be considered as the ultimate responsibility of the competitors. Thus, aggressive driving, running cars off the track, not yielding to passing signals, etc. will result in a black flag and a discussion of the driving behavior with competition officials in the penalty box. The time spent in the penalty box will be included in run time and serve as a reprimand as well as to inform the driver exactly what he/she did wrong. Drivers should be especially aware that open-wheeled cars are inherently dangerous due to the possibility of two tires touching and throwing one car into the air. The endurance event is a timed event; each driver is competing with the clock and is not racing other cars; therefore, aggressive driving is not necessary.

Passing during the Endurance Event is of primary concern. Two or more passing zones will be established on the track. Passing is allowed only in the passing zones and will be controlled by the track officials. These passing rules do not apply to a competing car passing cars that are disabled on the track or have spun-out and are not moving. The passing zones will be located at the exit of a turn onto a straight-away. There will be two parallel lanes separated by pylons. Upon entrance to the turn, the slower car will be blue flagged and will move to the inside of the turn and enter the inside passing lane; the faster car will move to the outside of the turn and will enter the outside lane. The faster car will make the pass in the outside lane and a flagman at the exit of the inside passing lane will signal the slower car when it can re-enter the track (after the faster car has completed the pass). All cars will use the outside lane under normal conditions.

ALL DRIVERS OF AN EVENT MUST ATTEND THE DRIVER'S MEETING FOR THE EVENT OR BE DISQUALIFIED FOR THAT EVENT. THE FACULTY ADVISOR WILL VERIFY ATTENDANCE.

4.10 Definitions

DOO	A cone is "Down or Out" if it has been: <ul style="list-style-type: none">● Knocked over or● The entire base of the cone lies outside the box marked around the cone in its undisturbed position.
DNF	Did Not Finish.
Entry Gate	The path marked by cones which establishes the required path the vehicle must take to enter the course.
Exit Gate	The path marked by cones which establishes the required path the vehicle must take to exit the course.
Gate	The path between two cones through which the car must pass. Two cones, one on each side of the course define a gate: Two sequential cones in a slalom define a gate.
Staging Area	An area prior to the entry to an event for the purpose of gathering those cars which are about to start.
OC	A car is Off Course if it does not pass through a gate in the required direction.

SAFETY STRUCTURE EQUIVALENCY FORM

This form must be completed and sent to the host **no later than MARCH 1, 1999** and then will be submitted to the FSAE™ Technical Committee for approval of designs which deviate from the Formula SAE® construction rules for Roll-over Protection or Side Impact Protection. This form must also accompany the vehicle to Safety and Technical Inspection.

University Name _____
Team Contact _____
Telephone Number _____
Department _____
Room and Building _____
Address _____
City, State, Zip _____

Faculty Advisor _____
Telephone Number _____
E-mail address _____

Rule Deviated (include number) _____
Description of Deviation (include drawing if necessary) _____

Attach Proof of Equivalency

Roll bar documentation should include material type(s), material certification(s), properties, heat treatment, and strength calculations showing equivalency. Side impact documentation should include material type(s), material certification(s), properties, heat treatment, cloth weights, resin type, fiber orientation, number of layers, core material, lay-up technique, and strength calculations showing equivalency.

TECHNICAL COMMITTEE DECISION/COMMENTS

**Send this form to: 1999 Formula SAE, Educational Relations, SAE International,
400 Commonwealth Drive, Warrendale, PA 15096-0001
Fax: (724) 776-0890**

1999 FORMULA SAE® INSPECTION SHEET

SCHOOL:	
TALLEST DRIVER:	HEIGHT:

CAR NUMBER:
NUMBER OF DRIVERS:

IMPORTANT

THIS FORM MUST STAY WITH THE VEHICLE UNTIL ALL THREE PARTS OF INSPECTION HAVE BEEN COMPLETED

PRESENT THE VEHICLE FOR INSPECTION IN THE FOLLOWING ORDER:

1. **SAFETY AND TECHNICAL INSPECTION**
2. **FUEL CAPACITY AND TILT TABLE INSPECTION**
3. **NOISE LEVEL AND BRAKING PERFORMANCE**

PART 1

SAFETY AND TECHNICAL INSPECTION

SAFETY EQUIPMENT

<p>HELMETS – Snell M85, SA-85, M90 or SA-90 rating properly sized.</p>	<p>GOGGLES/SHIELDS –made of impact resistant material</p>
<p>DRIVERS SUITS – SFV3.2A-1 minimum rating, single layer; Nomex, kynol, FPT, IWS(wool), Fiberglass, Durette, Fypro, PBI or Kevlar, NO PROBAN ALLOWED.</p>	<p>GLOVES/SHOES – Fire resistant material. No holes.</p>
<p>SAFETY HARNESS – 5 or 6 point with single metal quick release must meet SF1/16.1 spec and be labeled; 76 mm (3 in) lap belt must pass over pelvic area and wrap 180 degrees; 50 mm (2 in) shoulder belts must attach behind and below driver's neck but above a plane 40 degrees from horizontal; 50 mm (2 in) anti-submarine strap(s); attached securely to primary structure</p>	<p>FIRE EXTINGUISHER – 0.9 kg (2 lb) dry chemical 10BC or 1A10BC, Halon 1301 or 1211, AFFF, or CEA-614; if on board type actuation location must meet above intents. 2 Each</p>
<p>KILL SWITCH - One switch located driver's right, near roll bar accessible from outside of car, one switch located where it is accessible by driver, both switches must kill all electrical systems and be marked by SCCA symbol</p>	<p>ARM RESTRAINTS –Must be installed such that the driver can release them and exit unassisted regardless of vehicle's position.</p>

DRIVER PROTECTION

<p>ROLL BAR & ROLL HOOP – Mild steel; 25.4 m (1.0 in) O.D. 2.36 mm (.095 in) wall; Alloy steel; 25.4 mm (1.0) O.D. 1.57 mm (.065 in) wall. Other designs need approval documents; 4.5 mm (0.18 in) inspection hole must be drilled in a non-critical location; No composite material allowed.</p>	<p>SIDE IMPACT PROTECTION – A frame member must connect the roll bar and the roll hoop between 200 and 350 mm (7.87 and 13.78 in) above ground and at least one diagonal per side must connect the upper and lower frame rails between roll bar and roll hop, multiple tubes may form a triangulated structure off of the side of the upper and lower frame rails to achieve similar effect; monocoques require approval documents.</p>
<p>ROLL BAR HEIGHT – Helmet of tallest driver or 95th percentile male to be 50 mm (2.0 in) below line between top of front and rear roll hoops; if a point forward of the roll hoop is used approval document are required.</p>	<p>ROLL BAR BRACING – Mild steel; 25.4 m (1.0 in) O.D., 1.57 mm (.065 in), both sides, fore or aft, within 16 cm (6.3 in) of the top (vertically) and at least 30 degrees from vertical; braces may be removable if attachment method meets 1996 SCCA GCR page 132</p>
<p>ROLL HOOP LOCATION – No lower than top of steering wheel, with wheel in any orientation; two forward facing braces</p>	<p>ROLL BAR PADDING – Roll bar/Bracing that could contacted by helmet must be covered with 12.7 mm (0.5 in) thick padding</p>
<p>FRONT IMPACT PROTECTION – 150 mm (5.91 in) crush zone forward of driver's heels or master cylinders, whichever is foremost and 100 mm (3.94 in) minimum height be 200 mm (7.87 in) minimum width</p>	<p>HEAD RESTRAINT – 38.1 (1.5 in) padded non-resilient material such as ethafoam or ensolite not more than 25.4 mm (1.0) from helmet of drivers</p>

STEERING, SUSPENSION, BRAKES

<p>GROUND CLEARANCE – Sufficient to prevent any portion of the car from touching the ground during track events</p>	<p>WHEELS – Four wheels not in a line, 20.32 cm (8.0 in) minimum diameter</p>
<p>SUSPENSION – Fully operational with dampers front and rear; 25.4 mm (1.0 in) minimum wheel travel with driver in vehicle</p>	<p>STEERING – On at least two wheels with positive stops to prevent linkage lock up and tires from contacting any part of the car; 15 degrees max foreplay</p>
<p>BRAKES – Operating on all four wheels, one brake on limited slip is OK; brake system must be protected by structure of shields from drivetrain failure and minor collisions; unarmored plastic brake lines not allowed</p>	<p>BRAKE LIGHT - Car must be equipped with a working brake light of at least 15 watts clearly visible from the rear.</p>

PART 1 (cont.)

ENGINE COMPARTMENT

ENGINE – Four cycle piston engine 610 cc maximum swept displacement	EXHAUST ROUTING – Must not subject driver to exhaust fumes at any speed
RESTRICTOR – Diameter of restrictor must be no larger than 20 mm (0.7874 in) for gasoline fueled cars and 18 mm (0.7087 in) for M85 fueled cars	COMPRESSORS – Turbo or super chargers allowed if not OEM to engine; must be between restrictor and engine
THROTTLE CABLE – Must be at least 50.8 mm (2 in) from any exhaust component and out of exhaust stream; must have smooth operation with no possibility of binding or sticking; throttle actuation must use two springs to close throttle independently; push-pull type recommended by optional	SCATTERSHIELDS – 12 gauge 2.67 mm (0.105 in) mild steel protecting exposed high speed equipment such as clutches, drive belts, and chains
THROTTLE PEDAL – Must have positive stop before overstressing cable	JACKING POINT – Must have an exposed tube at the rear perpendicular to the longitudinal axis 30.46 cm (12.0 in) long by 25.4 mm (1.0 in) O.D.
OIL LEAKS – None permitted	CATCH TANKS – One quart minimum for oil breathers and coolant overflow
	COOLANT – Water only, no glycol or water pump lubricants added

FUEL SYSTEM

FUEL SYSTEM ROLL OVER PROTECTION – All parts of the fuel storage and supply system, engine air and fuel control systems, except air cleaner systems, must lie within a surface defined by the top of the roll bar and the outside top edge of the tires; the fuel tank must lie within the major structure	FUEL LINES – High pressure over 103.4 kPa (15 psi) fuel systems must use metal braided hose with threaded fittings; must be securely attached and protected from possible rotating equipment failure
FUEL FILLER NECK – 30 mm (1.2 in) min diameter x 80 mm (3.2 in) min vertical height with a scribed line inside 12.7 to 25.4 mm (0.5 to 1.0 in) below top of sight tube; design must prevent refueling spillage contacting driver, exhaust or ignition	BELLY PANS – Must be vented to prevent accumulation of fuel
	FUEL VENTS – Must have a check valve to prevent leakage when inverted and exit outside of the bodywork

INTERIOR

STEERING WHEEL – Near circular with driver operable quick disconnect	FLOOR CLOSEOUT PANEL – Required from foot area firewall; multiple panels are OK if gaps are less than 3.18 mm (1/8 in)
VISIBILITY – Must be adequate to front, rear and sides; roll bar and bracing must allow free rotation of drivers head to 90 degrees either side	FIREWALL – Fire resistant material, must separate driver compartment from fuel supply and liquid cooling systems; pass throughs OK if grommets are used; multiple panels OK but gaps should be sealed
MIRRORS – Must have functional rear view mirrors	

EXTERIOR, GENERAL

WHEELBASE – Minimum 1524 mm (60 in)	BODY & STYLING – Open wheeled, open cockpit, formula style body
AERODYNAMICS – No power ground effects allowed; wing leading edges must be 12.7 mm (0.5 in) minimum radius and 19.05 (0.75 in) minimum radius if ahead of the front of the front tires; all other edges must be 3.175 mm (1/9 in) minimum radius; no wider than outside edge of tires	FASTNERS – Steering, braking, harness, and suspension systems must use SAE Grade 6 or Metric Grade M8.8 or higher specs (AN/MS/NAS); rod ends in single shear must be captured by a washer larger than the ball diameter; adjustable tie-rod ends must have nuts to prevent loosening.
EGRESS – 5 seconds max to exit to side of vehicle from fully seated position with all safety equipment; wings must remain fixed in position.	CAR NUMBERS & DECALS – Numbers must be 15.24 cm (6 in) tall minimum displayed on both sides of vehicle; Event, sponsor and fuel decals must be clearly displayed on vehicle.

NON-COMPLIANCE/COMMENTS:

APPROVED BY: _____

DATE: _____

PART 2**FUEL CAPACITY AND TILT TABLE INSPECTION**

FUEL TANK CAPACITY - 13 liter (3.5 US gallon) max. for M85 fueled cars; 7.5 liter (2 US gallon) max. for gasoline fueled cars	FUEL SPILLAGE - No fuel spill permitted when car is tilted to 45 degrees in the direction most likely to create spillage; Tanks must be filled to scribe line
FUEL STICKER - M85 fueled cars must have M85 sticker	ROLL OVER STABILITY - Car must not roll over when tilted to 57 degrees in either direction with tallest driver on board
PERMANENT FUEL LEVEL LINE - between 13 mm and 25 mm (0.5 inch and 1 inch) below top of the sight tube.	
NON-COMPLIANCE/COMMENTS:	

APPROVED BY: _____

DATE: _____

PART 3**NOISE LEVEL AND BRAKING PERFORMANCE INSPECTION**

NOISE LEVEL - 98 dBA maximum 7.5 m (24.6 feet) from car during full power acceleration in first or second gear at maximum engine rpm and 15 m (49.2 feet) from starting line: Measurements take on both sides of vehicle	BRAKING PERFORMANCE - Must lock-up all four wheels on dry asphalt at any speed - evaluated after point of sound level measurement. If adjustments are made to the vehicle after three failed attempts before retest, the car may run on the Practice Track without the final Brake Performance Tech Sticker
NOISE LEVEL -	ATTEMPTS -
NON-COMPLIANCE/COMMENTS:	

APPROVED BY: _____

DATE: _____

1999 FSAE™ COST EVENT ADDENDUM

SCHOOL _____ CAR NUMBER _____

(Please indicate decreases using bracketed numbers)

	Section	Original Reported Total	New Reported Total	Difference	Cost Judge Initials
1	Brake System				
2	Engine & Drivetrain				
3	Frame & Body				
4	Instruments, Wiring & Accessories				
5	Miscellaneous, Finish & Assembly				
6	Steering System				
7	Suspension & Shocks				
8	Wheels, Wheel Bearings & Tires				

Total Vehicle

\$ _____ \$ _____ \$ _____

Explanation of Differences Listed Above:

1

2

3

4

5

6

7

8

Accepted By: _____
Date: _____

Entered By: _____
Date/Time: _____

Addendums will be accepted only at the time of registration

These forms will then be forwarded to the cost event judges the morning of the Cost Event.

THE 1999 FSAE™ COST REPORT MUST FOLLOW THE ORGANIZED LIST OF SYSTEMS AND COMPONENTS OUTLINED BELOW. ANY QUESTIONS AS TO THE CORRECT LOCATION OF THE SPECIFIC ITEMS SHOULD BE SUBMITTED TO THE RULES COMMITTEE BY 3/22/99 AND CLARIFICATION WILL BE MADE.

1) Brake System . . .

Brake Fluid	Brake Master	Labor	Graphics And/Or
Brake Lines	Cylinder	Sub-Totals of Sub-	Photographs
Calipers	Brake Discs	Components	Receipts/Back-up
Brake Pads	Fasteners	Area Total	

2) Engine and Drivetrain . . .

Engine	Injectors	Radiator	Differential
Engine Mfr. (Name)	Engine Electronics	Coolant	CV Joints/U Joints
Engine (cc)	Engine Mounts	Overflow Bottles	Engine/Diff Oil
Displacement	Oil Filter	Coolant Lines	Fasteners
Exhaust Manifold	Spark Plugs	Radiator Fans	Labor
Muffler	Fuel Tank	Hose Clamps	Sub-Totals of Sub-
Intake Manifold	Fuel Pump	Oil Cooler	Components
Restrictor	Fuel Pressure Reg.	Chain/Belt	Area Total
Air Filter	Fuel Filter	Axles	Graphics And/Or
Turbo/Super Charger	Fuel Lines/Rails	Differential Mounts	Photographs
Carburetor/ Throttle Body	Fuel Vent/ Check Valve	Sprocket/Pulleys	Receipts/Back-Up
		Differential Bearings	

3) Frame & Body . . .

Pedals	Body Material	Aerodynamic Wing	Area Total
Shifter	Body Processing	Shifter Cable/Linkage	Graphics And/Or
Throttle Controls	Body Attachments	Final Assembly	Photographs
Frame Tubes	Mounts Integral to	Fasteners	Receipts/Back-Up
Welding	Frame	Labor	
Tubes Cuts/Bends	Floor Pan	Sub-Totals of Sub-	
Tube end Preps	Clutch	Components	

4) Instruments, Wiring & Accessories . . .

Tachometer	Fuses	Relays	Labor
Wire/Connectors	Water Temp Gage	Starter Button	Area Total
Oil Press	Brake Light Bulb	Kill Switch	Graphics And/Or
Gage/Light	Solenoids	Fasteners	Photographs
Dash Panel	Indicator Lights	Sub-Totals of Sub-	Receipts/Back Up
	Battery	Components	

5) Miscellaneous, Safety, Finish and Assembly . . .

Seats	Fire Extinguisher	Sub-Totals of Sub-	Area Total
Safety Harness	Fire Wall	Components	Graphics And/Or
Paint - Frame	Mirrors	Fasteners	Photographs
Paint - Body	Safety Shields	Labor	Receipts/Back-up
Brake light - housing	Headrest/Restraints		

6) Steering System . . .

Steering Rack	Stg Whl Quick Rel.	Sub-Totals of Sub-	Graphics And/Or
Tie Rods	Fasteners	Components	Photographs
Steering Shaft	Labor	Area Total	Receipts/Back-up
Steering Wheel			

7) Suspension & Shocks . . .

Shocks	A/Arms or Equivalent	Fasteners	Graphics And/Or
Springs	Rod Ends	Labor	Photographs
Suspension	Front Uprights	Sub-Totals of Sub-	Receipts/Back-up
Mechanism	Rear Uprights	Components	
Pushrods/Pullrods		Area Total	

8) Wheels, Wheel Bearings & Tires . . .

Wheels	Wheel Bearings	Labor	Graphics And/Or
Lug Nuts	Front Hubs	Sub-Totals of Sub-	Photographs
Tires	Rear Hubs	Components	Receipts/Back-Up
Valve Stems	Wheel Studs	Area Total	
Wheel Weights	Fasteners		

Report Evaluation (Overall Presentation)

Introduction/Cover	Tabs	Back Up Data
Letter	Organized Format	Complete
Table of Contents	Cover/Binder	Graphics and/or
Cost Summary		Pictures
		Content Accuracy

NOTE: After each section or area, include the corresponding pictures, sketches, diagrams, blueprints (if possible), back-up and receipts necessary for that area. The cost of fasteners and brackets are to be included in their respective sub-assemblies. The costs of the sub-assemblies must include labor as if each sub-assembly were bought from a separate supplier and the car was assembled as a finished product.

Area Name (For Example: Frame & Body)

Component Name

Widget # 1

Sub-Components

- 1) Sprocket
- 2) Do-Hickey
- 3) Whatchamacallit
- 4)
- etc.

Item Cost

\$17.57
\$6.98
\$5.95

Total Sub-Components →

\$ 30.50

Assembly Labor to assemble component to vehicle

@ \$35.0 # of minutes: 15
 # of workers: 2

\$ 17.50

Total Component Cost

\$ 48.00

Sub-Component Name	Qty	Mat'l Cost Each	Operation	Total Per Vehicle
1) Sprocket	<u>3</u>	<u>\$ 4.65</u>		<u>\$ 13.95</u>

Mfg Operations:

- 1) Drilled Holes 6 @ 0.35 \$ 2.10
- 2) Weld, 1 inch 1 @ 0.35 \$ 0.35
- 3) _____ @ _____ _____
- 4) _____ @ _____ _____
- etc. _____ @ _____ _____

Total Mfg. Operations Cost → **\$ 2.45**

Labor: # of min: 2 # of operators: _____ @ \$35.00/hr.

Labor Cost → **\$ 1.17**

Explanation: Screw sub-assembly together
 Total Sub-Component Cost **\$ 17.57**

Sub-Component Name	Qty	Mat'l Cost Each	Operation Total	Total Per Vehicle
2) Do-Hickey	<u>1</u>	<u>\$ 6.98</u>		<u>\$ 6.98</u>

Mfg Operations:

- 1) Purchased _____ @ _____ \$ _____
- 2) _____ (Mfrs receipt on pg. 34) @ _____ \$ _____
- etc. _____ @ _____ \$ _____

Total Mfg. Operations Cost → _____

Labor: # of min: _____ # of operators: _____ @ \$35.00/hr.

Labor Cost → _____

Explanation: _____
 Total Sub-Component Cost **\$ 6.98**

Area Total

\$ 540.00

(All Components & labor for area)

SCHOOL _____

CAR NUMBER _____

PRESENTATION JUDGING

Score the following categories on the basis of 0-10 points each according to the following scale (any number or fraction along this scale may be used).

- 0.0 = inadequate or no attempt
- 2.5 = attempted but below expectation
- 5 = average or expected
- 7.5 = above average but still lacking
- 10 = excellent, perfectly meets intent

_____ **CONTENT:** Were the concepts presented appropriate and adequate to explain how the car meets the intent of the customer? Were enough technical details presented without being boring?

_____ **ORGANIZATION:** Were the concepts presented in a logical order progressing from basic concept and showing how the engineering accomplished the concept? Was it clear to the audience what was to be presented and what was coming next? Were distinct introduction and overviews as well as summary and conclusions given?

_____ **VISUAL AIDS:** Were visual aids used or clear visual references made to the car? Were the illustrations visible for all of the audience?

_____ **DELIVERY:** Did the presenter speak in a clear voice? Did the presenter show enthusiasm and promote confidence in the technical aspects? Did he maintain eye contact?

_____ **QUESTIONS:** Did the answer illustrate that the team fully understood the question? Is there doubt that the team understood the answer? Did the team promote complete confidence in their response to the questions?

_____ **TOTAL = PRESENTATION POINTS (50 points maximum)**

COMMENTS: _____

DESIGN JUDGING

_____ **AESTHETICS (0-5)** - Does the vehicle look attractive? Does it have a high performance appearance?

_____ **MECHANICAL DESIGN (0-20)** - Do components appear to have been sized properly for the load? Does form follow function? Do brackets serve more than one purpose?

_____ **CHASSIS DESIGN (0-30)** - Does the suspension design consider kinematics, roll center placement or load transfer? How was vehicle handling designed for and developed? How was brake system designed? Was weight distribution and C.G. height optimized?

_____ **MANUFACTURABILITY (0-10)** - Can 1000 units per year be economically produced? Was manufacturing and ease of assembly a major consideration?

_____ **SERVICEABILITY (0-15)** - Is the engine easy to service or remove? Is the suspension easy to adjust?

_____ **INNOVATIVENESS (0-15)** - Are any of the components or systems unique? Do the innovations add to the product's functions?

_____ **ERGONOMICS/INTERIORS/SAFETY (0-20)** - Is the vehicle designed to accommodate & function with a wide variety of body sizes? Are controls and instruments easy to use? Does the design consider occupant safety beyond the requirements?

_____ **POWERTRAIN (0-30)** - Does the engine have significant modifications with respect to fuel injection, turbocharging, intake or exhaust? Was the drivetrain well done? Were throttle, drive controls designed well?

_____ **BUILD QUALITY (0-5)** - Fit and finish, quality of materials, detail work, quality appearance.

_____ **MISCELLANEOUS (0 to -50)** - If this is a carry over from last year and did not undergo significant improvements, or if the team does not exhibit a good understanding of the car, then a penalty may be applied.

_____ **TOTAL = DESIGN POINTS (150 points maximum)**

COMMENTS: _____

ACTION DEADLINES

- | | | |
|----|--|------------------|
| 1. | Registration Form/Statement of Compliance (see 2.) | January 31, 1999 |
| 2. | Safety Structure Equivalency Form (see A - 1) | March 1, 1999 |
| 3. | Cost Report (see 4.2) | April 1, 1999 |
| 4. | Design Reviews (see 4.4) | April 20, 1999 |

